

LISY

Linux for System

1, 35, 80

Software Version 5.23

user manual

bontango@lisy80.com

07.08.2019

Table of contents

Important remark.....	5
1. Introduction.....	6
2. Quickstart.....	7
3. Put the LISY Image to the SD card.....	7
Etcher.....	8
Win32DiskImager.....	8
4. Installation.....	9
4.1. Replacing the original MPU.....	9
5. Dip Switch Settings.....	11
5.1. DIP Switch S1: options.....	11
5.1.1. S1-Dip1 -> Freeplay.....	11
5.1.2. S1-Dip2 -> Sound Emulation.....	11
5.1.3. S1-Dip3 -> Ballsave.....	11
5.1.4. S1-Dip4 -> MPF & 7digit option.....	11
5.1.5. S1-Dip5 -> SLAM.....	12
5.1.6. S1-Dip6 -> TEST.....	12
5.1.7. S1-Dip7 -> DEBUG.....	12
5.1.8. S1-Dip8 -> Autostart On.....	12
5.2. DIP Switch S2, Game selection.....	12
5.3. Options via K3(jumper).....	12
5.3.1. Fadecandy.....	12
5.3.2. WiFi/WLAN Hotspot.....	13
5.4. S3, graceful shutdown.....	13
6. Displays during boot.....	14
6.1. Gottlieb System1 (LISY1).....	14
6.2. Gottlieb System80 & 80A (LISY80).....	14
6.3. Gottlieb 80B.....	15
6.4. Bally/Stern (LISY35).....	15
7. LEDs.....	16
8. Performance.....	17
9. PIC flash utility (LISY35 only).....	18
9.1. Flash PIC.....	18
9.2. Start PIC Flash Utility.....	18
10. Webservice ‚LISYcontrol‘.....	20
10.1. Start.....	20

10.2. How to access.....	20
10.3. Switches.....	21
10.4. Lamps	23
10.5. Solenoids	24
10.6. Displays.....	25
10.7. Dip switches.....	26
10.8. Sound.....	27
10.9. NVRAM information	27
10.10. Software installed.....	27
10.11. Set hostname of the system.....	27
10.12. Initiate update of the system	27
10.13. Upload new lamp, coil or switch configuration files	27
11. Fadecandy	28
11.1. Hardware.....	28
11.2. Settings on LISY board	29
11.3. Software, files to edit and/or add	29
12. Coil Options	30
12.1. Pulse time mod for LISY1 coils.....	30
12.2. Pulse time mod for LISY80 coils.....	30
13. Option sound (BETA)	31
13.1. Hardware.....	31
13.2. Software, files to edit and/or add	32
13.2.1. LISY1	32
13.2.2. LISY80	33
14. Option '7 digit'	35
14.1. LISY1	35
14.1.1. Needed Hardware modification	35
14.2. LISY80	35
14.2.1. Needed Hardware modification	35
15. Image.....	36
15.1. Wireless config	36
15.1.1. Client mode	36
15.1.2. hotspot mode	37
15.2. Files in /boot/lisy1/roms & /boot/lisy80/roms	37
15.3. Files in /boot/lisy1/dips & /boot/lisy80/dips	37

15.4. Serial connection	37
16. LISY and MPF ‚Mission Pinball Framework‘	39
16.1. Connection in ‚master mode‘	39
16.2. Connection in ‚slave mode‘ (serial)	39
16.3. Connection in ‚slave mode‘ (IP)	41
16.4. Jumper settings on LISY board	41
16.5. Special configuration statements	42
16.5.1. Using lamp driver as coils (LISY1 & LISY80)	42
16.5.2. Switches with LISY1	42
16.5.3. Switches with LISY80	42
16.5.4. sounds	43
17. when things go wrong, LISY debug mode	45
17.1. testing/debugging on the bench	45
17.2. Preconditions	45
17.3. how to create a debug file	46
17.4. debugging options	46
Appendix A ‚Gamelist‘ LISY1	47
Appendix B ‚Gamelist‘ LISY80	48
Appendix C ‚Gamelist‘ LISY80 7digit	50
Appendix D ‚Gamelist‘ LISY35	51
Appendix E: example dip switch setting ‚default_lisy1_dips.csv‘	57
Appendix F: example dip switch setting ‚default_lisy80_dips.csv‘	58
Appendix G: Fadedcandy example mapping GI	59
Appendix H: Fadedcandy example mapping lamps	60
Appendix I: Error codes	61

Important remark

By using LISY it is possible to damage your pinball machine. As this is a private project with NO commercial interest the author accept no liability for any damage that may arise by using LISY!

1. Introduction

LISY uses a Raspberry PI Zero which is integrated in a self-designed PCB, used software basis is Raspbian und PINMAME.

With LISY1 you can control ALL Gottlieb System1 pinball machines by replacing the original MPU.

With LISY80 you can control ALL Gottlieb System80 pinball machines by replacing the original MPU.

With LISY35 you can control all 'early' Bally/Stern pinball machines by replacing the original MPU.

- I sell the PCB with programmed PICs at my cost price. I'm not looking to earn money with LISY, it is a 100% hobby project. This makes the solution cheap, depending on where you buy your components it is possible to create your Gottlieb replacement MPU for less than 60 €.
 - Die modified pinmame code is under GNU License, you can download it for free.
 - List of (standard) components is documented.
- As the solution is using pinmame gameplay is 100% compared to the original game
- Optional you can use 'Freeplay' or 'Ballsave'.
- There is a Web interface integrated ('LISYcontrol'). This means, by connecting to LISY it is possible to control each lamp and each solenoid via Web browser. Status of switches are shown on one page, and switch descriptions can be edited in a 'csv' table. Connection to LISY can be done by integrating LISY to your local LAN/WLAN or by letting start LISY a WLAN hotspot where you can connect to.

What do you need?

- Basic soldering skills (only one of the integrated circuits are in SMD size)
- Possibility to read/write micro SD cards
- Wireless LAN oder LAN if you want to use LISYcontrol
- A Gottlieb pinball Machine System 1, System 80, 80A or 80B Series, or a early bally pinball

Note: Because of copyright reasons the image does not contain any Gottlieb code/roms. You can find these roms (,pinamme' rom sets) at different places on the internet. Use of the rom sets is not allowed if you do not own the original prompts.

2. Quickstart

1. Put the latest image of LISY from my website tom the SD card (details see next section)
2. Get the ,pinname' rom set for your Gottlieb pinball and save it onto the SD card. The ,boot' partition is readable within windows.

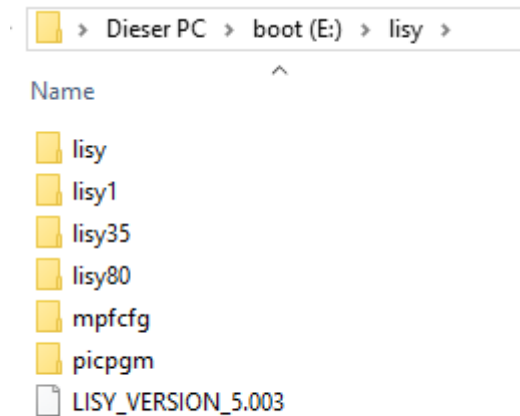

For System1 games (LISY1) save the .zip archive to “/lisy/lisy1/roms”, for System games (LISY80) save it in the “/lisy/lisy80/roms” folder and for Bally/Stern use “/lisy/lisy35/roms” folder.

See appendix A for the correct name of the .zip file. (Column ,Mame Name’)

3. Set all dips of switch S1 to OFF
4. Configure switch S2 according to your pinball (Appendix A or Appendix B)
5. Replace your original Gottlieb MPU with LISY1 or LISY80
6. Switch the Game ON
7. Enjoy

3. Put the LISY Image to the SD card

On my website you will find the latest version of LISY as an (zipped) image file. After unpacking the image can put on a 4GB SD card. As SD cards do differ in size it is possible that you got an error saying that there is not enough space on the SD card to put the image on. In this case you can try another 4GB SD card or use a 8GB SD card.

The image is based on Raspbian Stretch.

This article uses content from the eLinux wiki page [RPi Easy SD Card Setup](#), which is shared under the [Creative Commons Attribution-ShareAlike 3.0 Unported license](#)

[Etcher](#) is typically the easiest option for most users to write images to SD cards, so it is a good place to start. If you're looking for an alternative on Windows, you can use Win32DiskImager.

Etcher

- Download the Windows installer from etcher.io
- Run Etcher and select the unzipped LISY image file
- Select the SD card drive
- Finally, click **Burn** to write the LISY image to the SD card
- You'll see a progress bar. Once complete, the utility will automatically unmount the SD card so it's safe to remove it from your computer.

Win32DiskImager

- Insert the SD card into your SD card reader. You can use the SD card slot if you have one, or an SD adapter in a USB port. Note the drive letter assigned to the SD card. You can see the drive letter in the left hand column of Windows Explorer, for example **E:**
- Download the Win32DiskImager utility from the [Sourceforge Project page](#) as an installer file, and run it to install the software.
- Run the Win32DiskImager utility from your desktop or menu.
- Select the LISY image file you extracted earlier.
- In the device box, select the drive letter of the SD card. Be careful to select the correct drive: if you choose the wrong drive you could destroy the data on your computer's hard disk! If you are using an SD card slot in your computer, and can't see the drive in the Win32DiskImager window, try using an external SD adapter.
- Click 'Write' and wait for the write to complete.
- Exit the imager and eject the SD card.

4. Installation

LISY boards have the same edge connectors and same mounting holes as the original Gottlieb/Bally/Stern MPUs, so replacing of the board can be done in seconds.

4.1. Replacing the original MPU

See below a Gottlieb System80 game where the original MPU is already swapped with a LISY80 board as an example. LISY1 and LISY80 boards have roughly only half the size of the original MPU and as you see the only small change in positioning of the edge connectors is with 'J2'.

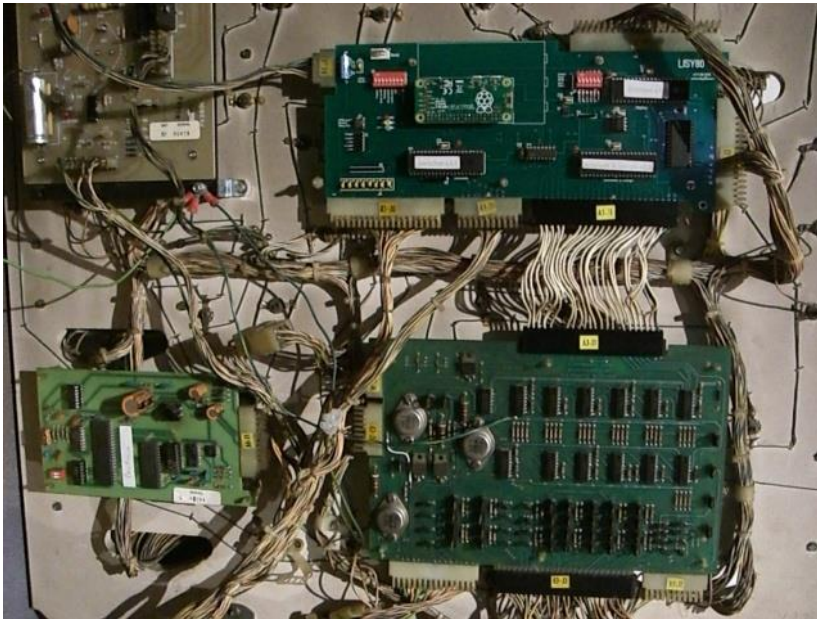

LISY80 in a Gottlieb System80 Pinball Machine 'Panthera'

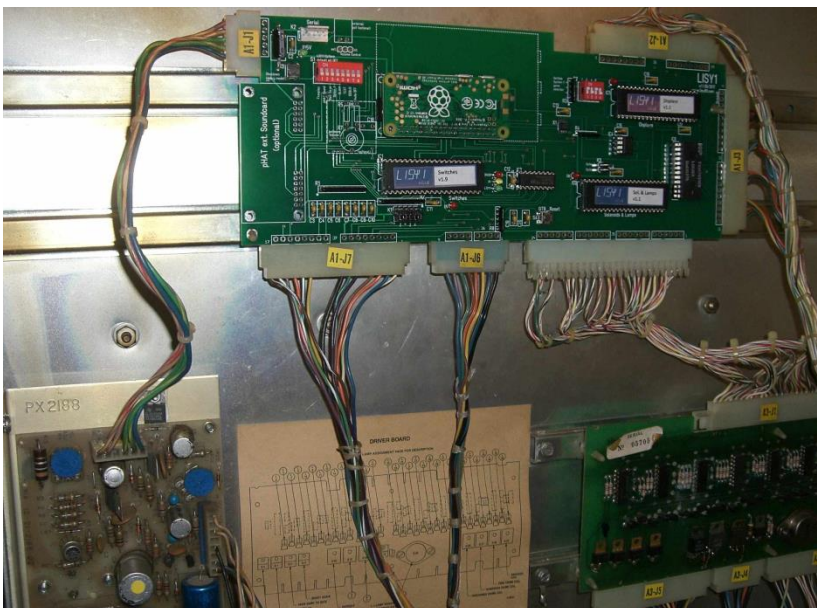

LISY1 in a Gottlieb System1 Pinball Machine 'Charlies Angels'

In addition, with LISY1 you can replace the edge connectors with more modern ones.

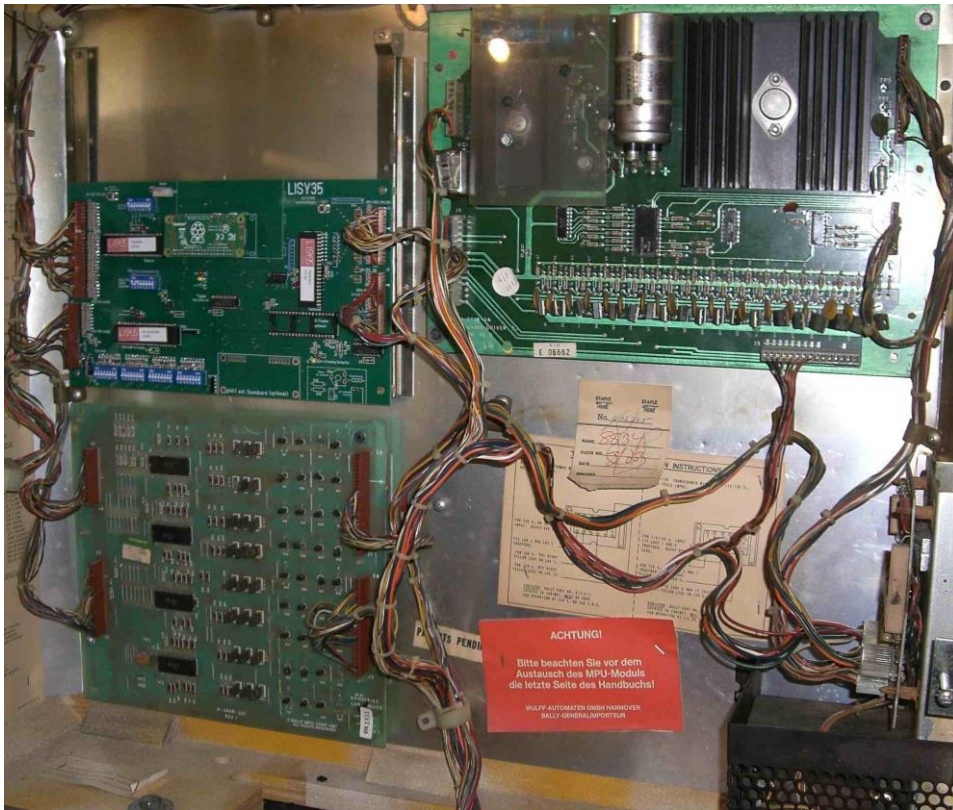

LISY35 in a Bally Pinball Machine 'Mata Hari'

5. Dip Switch Settings

Depending your needs and on your pinball machine, different settings can be done on the board. There are two main Switches, S1 and S2. S1 is for settings 'options' to the game, where with 'S2' you select which game you want to emulate.

5.1. DIP Switch S1: options

Default setting is all ,OFF', with this the game will react like the original game, typical settings are:

Switch S1								Mode
S1	S2	S3	S4	S5	S6	S7	S8	
off	off	off	off	off	off	off	off	start lisy (default)
on	off	off	off	off	off	off	off	start lisy (freeplay)
off	off	off	off	off	off	on	off	start lisy with debug
on	off	off	off	off	off	on	off	start lisy with debug (freeplay)
off	on	off	off	off	off	off	off	start lisy (internal sound)
off	on	off	off	off	on	off	off	start lisy (pinmame sound)
on	on	off	off	off	off	off	off	start lisy (internal sound & freeplay)
on	on	off	off	off	on	off	off	start lisy (pinmame sound & freeplay)
off	off	off	off	off	on	off	on	Start LISYcontrol
off	on	off	off	off	on	off	on	Start LISYcontrol (int. Sound)
off	off	off	off	off	on	on	on	Flash PIC (LISY35)
off	on	off	off	off	off	off	on	Flash Web-Utility client mode (LISY35)
off	on	off	off	off	off	on	on	Flash Web-Utility hotspot mode (LISY35)
off	off	off	on	off	off	off	on	MPF Master Mode
off	off	off	on	off	on	off	on	MPF Slave Mode (serial)
off	off	on	on	off	on	off	on	MPF Slave Mode (network)
off	off	off	off	off	off	off	on	nothing to start

5.1.1. S1-Dip1 -> Freeplay

With dip 1 to ,ON' the game is configured for ,Freeplay', meaning by pressing the ,Replay-Button' longer than 2 seconds, LISY will 'emulate a coin drop' to the left coin chute, giving you the credits configured to your game.

5.1.2. S1-Dip2 -> Sound Emulation

The LISY onboard soundcard is activated (optional)

5.1.3. S1-Dip3 -> Ballsave

Not implemented yet.

5.1.4. S1-Dip4 -> MPF & 7digit option

With Dip8 set to 'off' this activates the 7digit option, see chapter 'Option 7digit' for details.

With Dip8 set to 'on' this activate MPF (Server or Slave mode), see chapter MPF for details.

5.1.5. S1-Dip5 -> SLAM

With this dip to ON, the Gottlieb SLAM switch will be ignored

5.1.6. S1-Dip6 -> TEST

With dip6 to ,ON' after boot ,LISY80control' will be started instead of pinname. See chapter 7 for details. (Note: you can start ,LISY_control' after the game started by pressing the Gottlieb ,test' button for more than 2 seconds).

5.1.7. S1-Dip7 -> DEBUG

With dip 7 to ,ON' LISY will start in debug mode. See Chapter 'when things go wrong, LISY debug mode' for details.

5.1.8. S1-Dip8 -> Autostart On

With dip8 to ,ON' there is no autostart of LISY (pinname). Usually you choose this if you want to log in into the system (e.g. via ssh) to do maintenance or to start the mpf (missionpinballframework) option.

5.2. DIP Switch S2, Game selection

With Switch S2 you can select the Gottlieb/Bally/Stern Game which you want to emulate. **Take a look at Appendix A,B and C for valid selections dependignon which LISY product you have.**

Note: With LISY80 all selections lower than 40 will be interpreted as a System80/80A which has impact on the way LISY drives the displays.

5.3. Options via K3(jumper)



K3 jumper above of 'Solenoids & Lamps' PIC

5.3.1. Fadecandy

By selecting Jumper on the upper side LISY will try to connect to the 'fadecandy' Hardware. See section Fadecandy for details



5.3.2. WiFi/WLAN Hotspot

By selecting Jumper on the lower side LISY will start an internal wireless LAN hotspot instead of trying to connect to your local wireless infrastructure. See section 'wireless config' for details.



5.4. S3, graceful shutdown

With S3 the system will do an immediate 'shutdown'. This is only important (and advisable!) in debugging mode, as with debugging mode the Linux OS is running in read/write. Switching of the power with doing a shutdown beforehand may damage your file system on the SD card.

In normal mode, the system is running in 'read/only' mode, so you can safely switch off power at any time.

6.3. Gottlieb 80B

Phase 1 (boot Raspberry PI)

Line 1: 'LISY80B' ,GAME NO xx' (xx is the internal number of appendix B)

Line 2: ,WAIT FOR PI'

Phase 2 (start LISY80)

Line 1: ,NAME' 'Pinmame Name'

Line 2: ,BOOT LISY80 V , Software Version LISY80'

LED D3 (yellow) 'PI' went to ON

Phase 3 (LISY80)

The selected game is emulated, LED D4 (green) 'LISY80' went to ON

6.4. Bally/Stern (LISY35)

Note: due to hardware restriction of Bally displays only numbers can be displayed

Phase 1 (boot Raspberry PI)

Display 0: '115435',

Display 1: xxx (xxx is the internal number of appendix B)

Display 2: '1111'

Display 3: , 0 11'

Phase 2 (start LISY35)

Display 0: '115435'

Display 1: xxx (xxx is the internal number of appendix B)

Display 2: '6001'

Display 3: Software Version of LISY

LED D5 (yellow) 'PI' went to ON

During initialization of LISY the status display will show software versions of the different pics. Starting with display pic (leading '1'), then coil pic (leading '2') and switch pic (leading '3')

Phase 3 (LISY35)

The selected game is emulated, LED D6 (green) 'LISY35' went to ON

7. LEDs

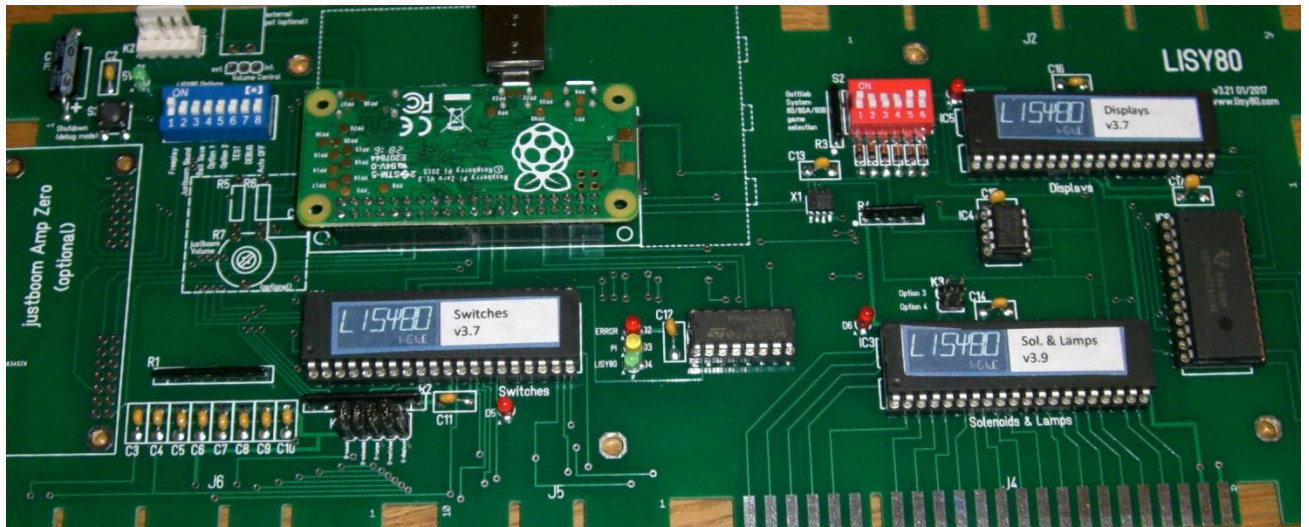

D1 – Green – with D1 ON, you have 5Volt

D2 – Red ,Error‘ – In case there was an internal error

D3 – Yellow ,PI‘ – On at the time the PI is ,up and running‘

D4 – Green ,LISY1/LISY80/LISY35‘ – On in case LISYS1/Lisy80/Lisy35 is ,up and running

D5 – Red – does indicate activities on the switches

D6 – Red – does indicate activities on the solenoid and/or lamps

D13 – Red – does indicate activities on the displays

➔ RTH-TODO: split up into 1/35/80

8. Performance

LISY does use ,pinmame' to emulate a pinball machine. In order to be able to 'fine adjust' or even to 'tune up' your specific game, with LISY you can adjust the speed the emulation is running.

For LISY80 take a look at the file ,/lisy80/cfg/lisy80games.csv' column ,throttle'. The default value is 1000.

For LISY1 take look at the file ,/lisy1/cfg/lisy1games.csv'; default value here is 3000.

For LISY1 take look at the file ,/lisy35/cfg/lisy35games.csv'; default value here is 5000.

Lowering the value will speed up the game and increasing the value will result in a slower gameplay. The file is in 'CSV-format' and can be edited within windows.

9. PIC flash utility (LISY35 only)

In case of Software Updates with LISY35 there is the possibility to flash PICs.

Hardware Version 1.2 has an additional socket (marked as 'Flasher (optional)') where you have to put the PIC which you want to update

With Hardware Version 1.3 you can leave the PIC in its socket and just place 4 Jumpers into the area marked as 'flash only' for the PIC you want to update.

Two modes are possible: For the first ('Flash PIC') you just need to prepare your SD card beforehand, placing the right hex file. For the second one you need network connectivity to your LISY card either by using the internal hotspot or with 'client mode' by connecting to your existing WLAN at home.

You can select the mode via S1:

Switch S1								Mode
S1	S2	S3	S4	S5	S6	S7	S8	
off	off	off	off	off	on	on	on	Flash PIC (LISY35)
off	on	off	off	off	off	off	on	Flash Web-Utility client mode (LISY35)
off	on	off	off	off	off	on	on	Flash Web-Utility hotspot mode (LISY35)

9.1. Flash PIC

You need to prepare the SD card for that. Place the hex-image you want to flash the PIC with to the directory /lisy/lisy/picpgm. The file has to have the extension '.hex'. Make sure there is only **one** file in that directory.

Place a PIC into the socket 'Flasher (optional)'

Select Switch S1 dip6=ON, dip7=ON and dip8=ON (all other OFF).

Power LISY over the Raspberry PI with a USB power supply (2 Ampere Minimum) or place it in a Bally/Stern pinball.

After boot, LISY will try to flash the PIC in the 'Flasher' socket with the stored hex file. On success the green 'LISY35' LED (D6) will went on. In case of an error the red 'ERROR' LED (D4) will went on.

9.2. Start PIC Flash Utility

By selecting S1 dip2==ON and dip8==ON LISY will start his internal webbrower (just like with LISYcontrol) and you can upload hex files and control the internal flasher with a standard webbrower. For connection option have a look to section 'wireless config'



[Back to Flash utility Homepage](#)

flash new program into PIC at 'Flasher' socket (Extension have to be ".hex")

Keine Datei ausgewählt.

10. Webservice ,LISYcontrol'

With LISYcontrol (LISY1control/LISY80control/LISY35control) you have full control over the hardware of your Gottlieb pinball machine. Once started you can access it with any Web browser within your network. For this your raspberry PI needs a valid IP-address.

See section '9 Image' and section 11 'wireless config' for more details how to get LISY connected to your local network.

10.1. Start

There are two possibilities to start LISYcontrol.

With S1,dip 6 (TEST) and dip8 (Auto Off) to ON at boot time LISYcontrol will be started instead of pinmame.

In a running game, push the Gottlieb Test button (located in the front door of the pinball) for more than 3 seconds. LISY will shutdown the pinmame emulation and start LISYcontrol instead.

10.2. How to access

,LISYcontrol' will detect if the system has an valid IP-Address and show the IP via the connected displays. In your web browser just type in this IP-address and it should come up with a screen similar to the one below. (here the default hostname 'lisy' is mapped to the IP Address)

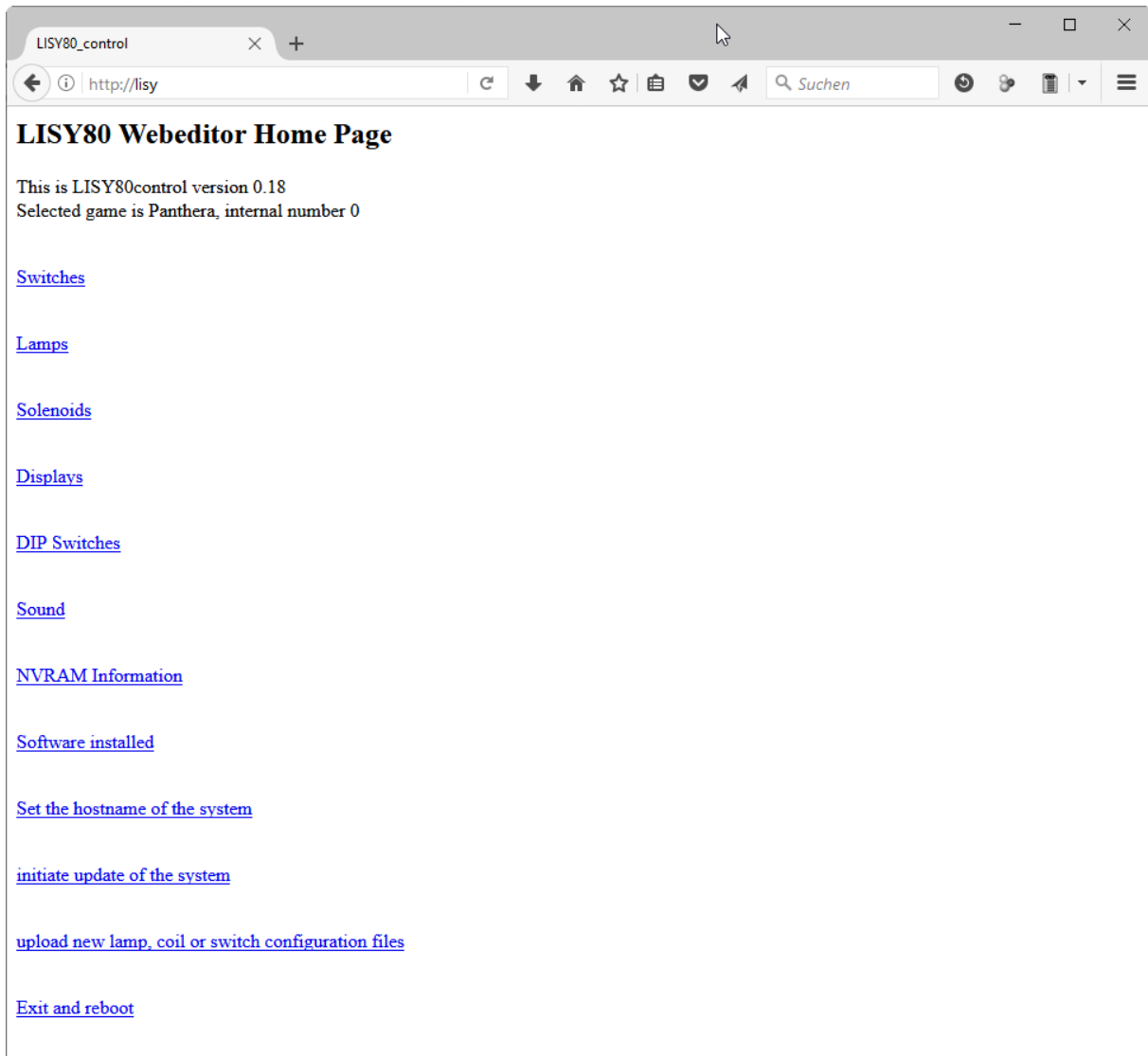

10.3. Switches

You will see an overview of all switches, together with the current state, of your pinball machine. The screen will do a 'refresh' any second or so. Closed switches are marked red, open switches are marked green.

The descriptions are configurable via the file '<NNN>_lisy1_switches.csv' (folder /lisy1/control/switch_descriptions) for a system1 machine; respective '<NNN>_lisy80_switches.csv' (folder /lisy80/control/switch_descriptions) for a system80 machine. With NNN as the internal number of your Gottlieb game, with leading zeros if it's shorter than three digits, according to appendix A for Lisy1 and appendix B for Lisy80.

In case the system does not find a description file with the current Gottlieb game number, it will take the file 'default_lisy1_switches.csv'; respective 'default_lisy80_switches.csv' for a system80 game.

LISY80_control

lisy/lisy80_switches.php

[Back to LISY80 Homepage](#)

Selected game is Panthera, internal number 0

Switch 00 #1 Yellow Drop Target	Switch 01 #2 Yellow Drop Target	Switch 02 #3 Yellow Drop Target	Switch 03 Yellow Rollovers	Switch 04 Bull's Eye Target	Switch 05 #1 Rollover	Switch 06 NOT USED	Switch 07 Test Switch
Switch 10 #1 Blue Drop Target	Switch 11 #2 Blue Drop Target	Switch 12 #3 Blue Drop Target	Switch 13 Blue Rollovers	Switch 14 Rollover Buttons	Switch 15 #2 Rollovers	Switch 16 NOT USED	Switch 17 Left Coin Switch
Switch 20 #1 White Drop Target	Switch 21 #2 White Drop Target	Switch 22 #3 White Drop Target	Switch 23 White Rollovers	Switch 24 Pop Bumpers	Switch 25 #3 Rollover and Spin Target	Switch 26 NOT USED	Switch 27 Right Coin Switch
Switch 30 #1 Green Drop Target	Switch 31 #2 Green Drop Target	Switch 32 #3 Green Drop Target	Switch 33 Green Rollovers	Switch 34 10 Point Contacts	Switch 35 Hole	Switch 36 NOT USED	Switch 37 Center Coin Switch
Switch 40 NOT USED	Switch 41 NOT USED	Switch 42 NOT USED	Switch 43 NOT USED	Switch 44 NOT USED	Switch 45 NOT USED	Switch 46 NOT USED	Switch 47 Replay Button
Switch 50 NOT USED	Switch 51 NOT USED	Switch 52 NOT USED	Switch 53 NOT USED	Switch 54 NOT USED	Switch 55 NOT USED	Switch 56 NOT USED	Switch 57 Tilt Switch
Switch 60 NOT USED	Switch 61 NOT USED	Switch 62 NOT USED	Switch 63 NOT USED	Switch 64 NOT USED	Switch 65 NOT USED	Switch 66 NOT USED	Switch 67 Outhole
Switch 70 NOT USED	Switch 71 NOT USED	Switch 72 NOT USED	Switch 73 NOT USED	Switch 74 NOT USED	Switch 75 NOT USED	Switch 76 NOT USED	Switch 77 NOT USED

10.4. Lamps

You will see an overview of all lamps, together with the current state, of your pinball machine. By pushing the button you can switch ON or OFF the specific lamp. A lamp in state lamp will change the color to yellow.

The descriptions are configurable via the file '<NNN>_lisy1_lamps.csv' (folder /lisy1/control/lamp_descriptions) for a system1 machine; respective '<NNN>_lisy80_lamps.csv' (folder /lisy80/control/lamp_descriptions) for a system80 machine. With NNN as the internal number of your Gottlieb game, with leading zeros if it's shorter than three digits, according to appendix A for Lisy1 or appendix B for Lisy80.

In case the system does not find a description file with the current Gottlieb game number, it will take the file default_lisy1_lamps.csv'; respective default_lisy80_lamps.csv' for a system80 game.

Note: For Bally (LISY35) some game shave a second Lampdriverboard, you can use '<NNN>_lisy35_lamps2.csv' respective 'default_lisy35_lamps2.csv'

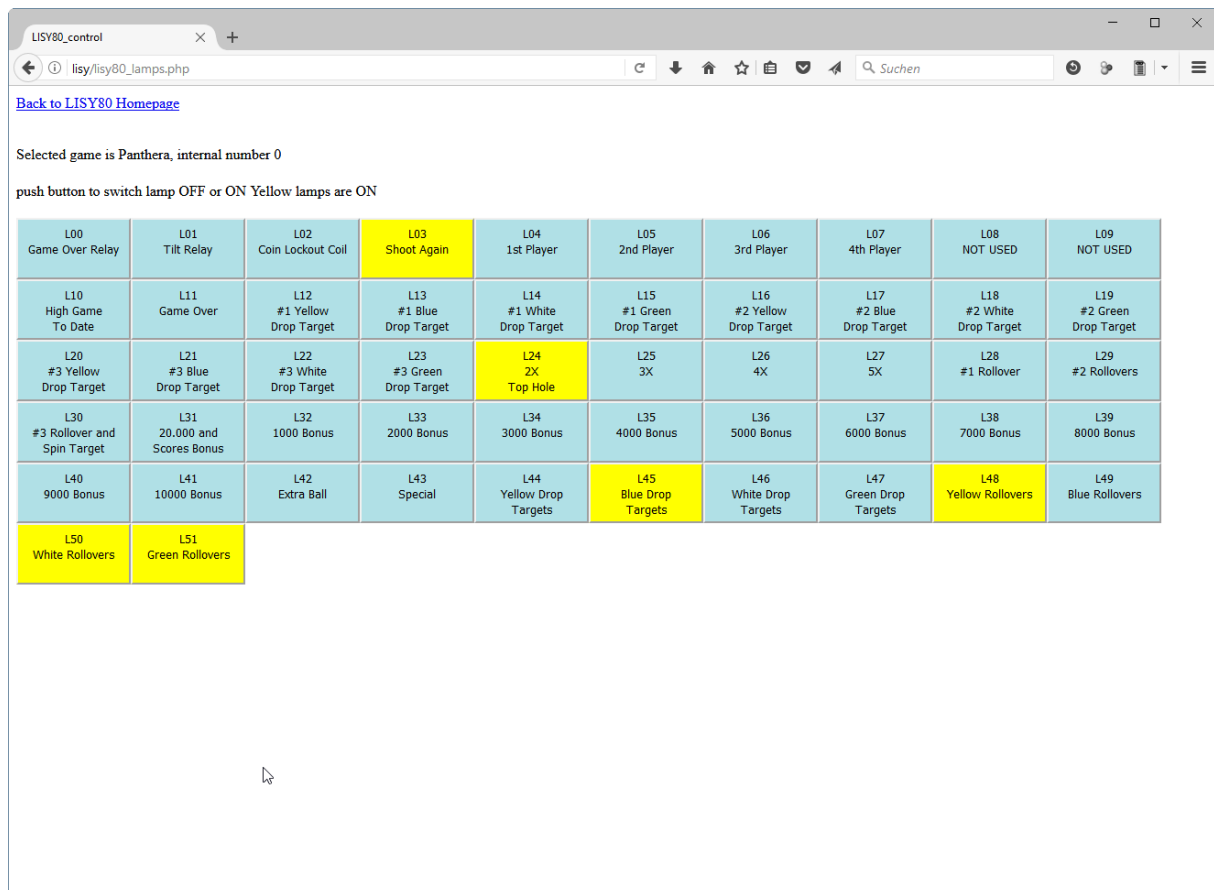

LISY80_control

Back to LISY80 Homepage

Selected game is Panthera, internal number 0

push button to switch lamp OFF or ON Yellow lamps are ON

L00 Game Over Relay	L01 Tilt Relay	L02 Coin Lockout Coil	L03 Shoot Again	L04 1st Player	L05 2nd Player	L06 3rd Player	L07 4th Player	L08 NOT USED	L09 NOT USED
L10 High Game To Date	L11 Game Over	L12 #1 Yellow Drop Target	L13 #1 Blue Drop Target	L14 #1 White Drop Target	L15 #1 Green Drop Target	L16 #2 Yellow Drop Target	L17 #2 Blue Drop Target	L18 #2 White Drop Target	L19 #2 Green Drop Target
L20 #3 Yellow Drop Target	L21 #3 Blue Drop Target	L22 #3 White Drop Target	L23 #3 Green Drop Target	L24 2X Top Hole	L25 3X	L26 4X	L27 5X	L28 #1 Rollover	L29 #2 Rollovers
L30 #3 Rollover and Spin Target	L31 20.000 and Scores Bonus	L32 1000 Bonus	L33 2000 Bonus	L34 3000 Bonus	L35 4000 Bonus	L36 5000 Bonus	L37 6000 Bonus	L38 7000 Bonus	L39 8000 Bonus
L40 9000 Bonus	L41 10000 Bonus	L42 Extra Ball	L43 Special	L44 Yellow Drop Targets	L45 Blue Drop Targets	L46 White Drop Targets	L47 Green Drop Targets	L48 Yellow Rollovers	L49 Blue Rollovers
L50 White Rollovers	L51 Green Rollovers								

10.5. Solenoids

You will see an overview of all solenoids of your pinball machine. By pushing the button you can 'pulse' the specific solenoid.

The descriptions are configurable via the file '<NNN>_lisy1_coils.csv' (folder /lisy1/control/coil_descriptions) for a system1 machine; respective '<NNN>_lisy80_coils.csv'(folder /lisy80/control/coil_descriptions) for a system80 machine. With NNN as the internal number of your Gottlieb game, with leading zeros if it's shorter than three digits, according to appendix A for Lisy1 or appendix B for Lisy80.

In case the system does not find a description file with the current Gottlieb game number, it will take the file default_lisy1_coils.csv'; respective default_lisy80_coils.csv' for a system80 game.

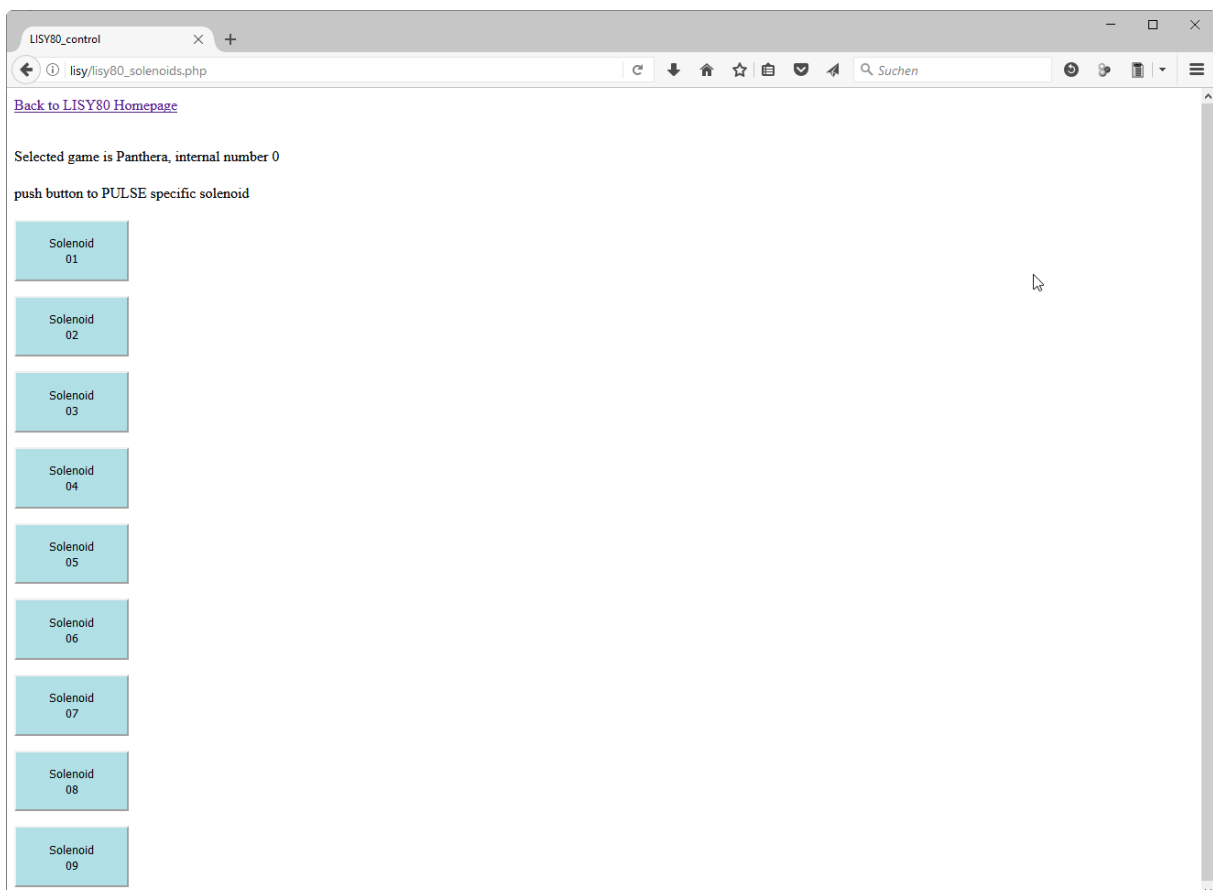

10.6. Displays

Test your displays. Type in the text in the field for the display you want to set and push the button.

Note that in the example screenshot below, the displays are still showing the current IP address of the system, which is: 192.168.1.27

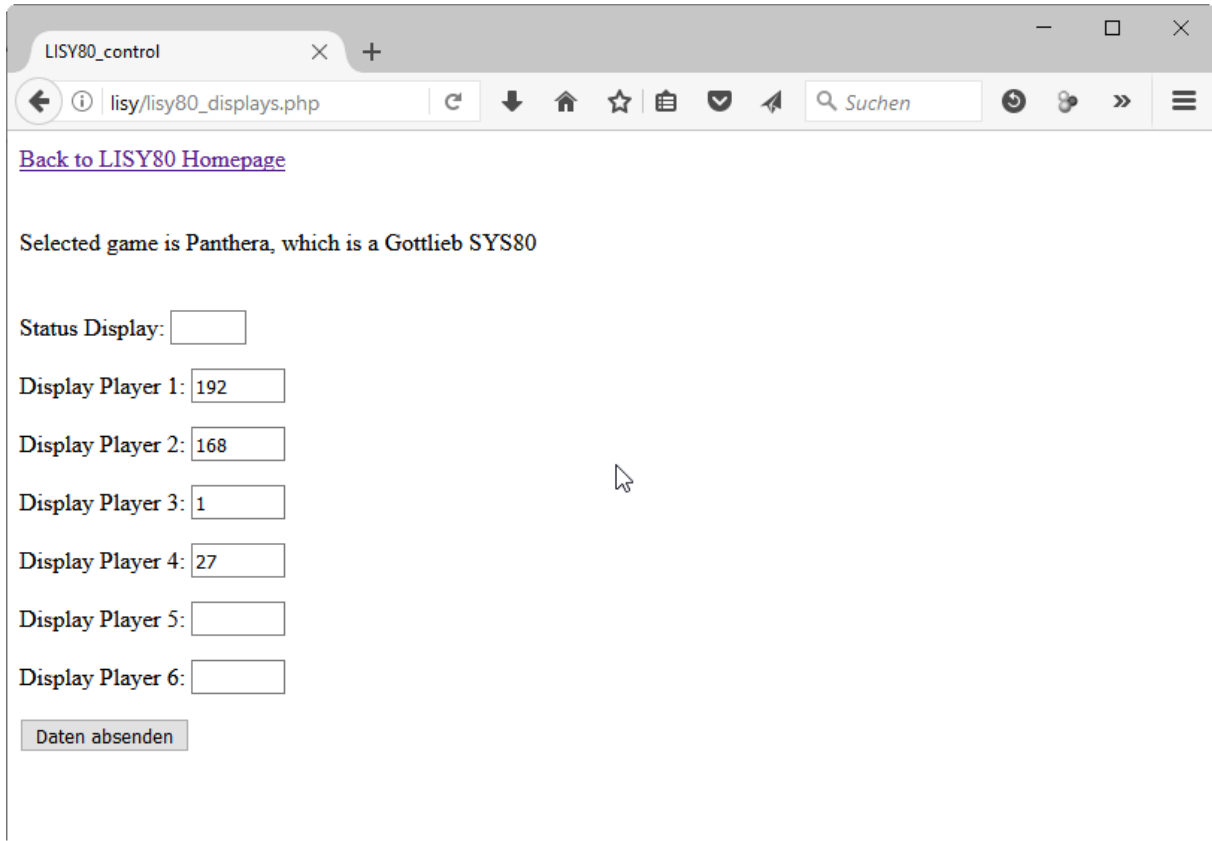

LISY80_control

lisy/lisy80_displays.php

[Back to LISY80 Homepage](#)

Selected game is Panthera, which is a Gottlieb SYS80

Status Display:

Display Player 1:

Display Player 2:

Display Player 3:

Display Player 4:

Display Player 5:

Display Player 6:

10.7. Dip switches

As LISY1 and LISY80 do not have the 'hardware' Gottlieb 'dip switches' on board, the dip switch configuration comes also as a 'csv-file' and will be read at boot time of the pinname emulation.

LISY35 comes with four dip switch banks like the original mpu, however you can also use csv files here which will override the dip switch settings on the board.

The descriptions are configurable via the file '<NNN>_lisy1_dips.csv' (folder /lisy1/dips) for a system1 machine; respective '<NNN>_lisy80_dips.csv' (folder /lisy80/dips) for a system80 machine. With NNN as the internal number of your Gottlieb game, with leading zeros if it's shorter than three digits, according to appendix A for Lisy1 or appendix B for Lisy80.

In case the system does not find a description file with the current Gottlieb game number, it will take the file default_lisy1_dips.csv'; respective default_lisy80_dips.csv' for a system80 game.

For dip switches LISYcontrol can be used as an editor. Just type in the descriptions and press 'set values' at the end and LISYcontrol will store your descriptions. In case there is no current specific description file for your pinball machine, LISYcontrol will create a new one.

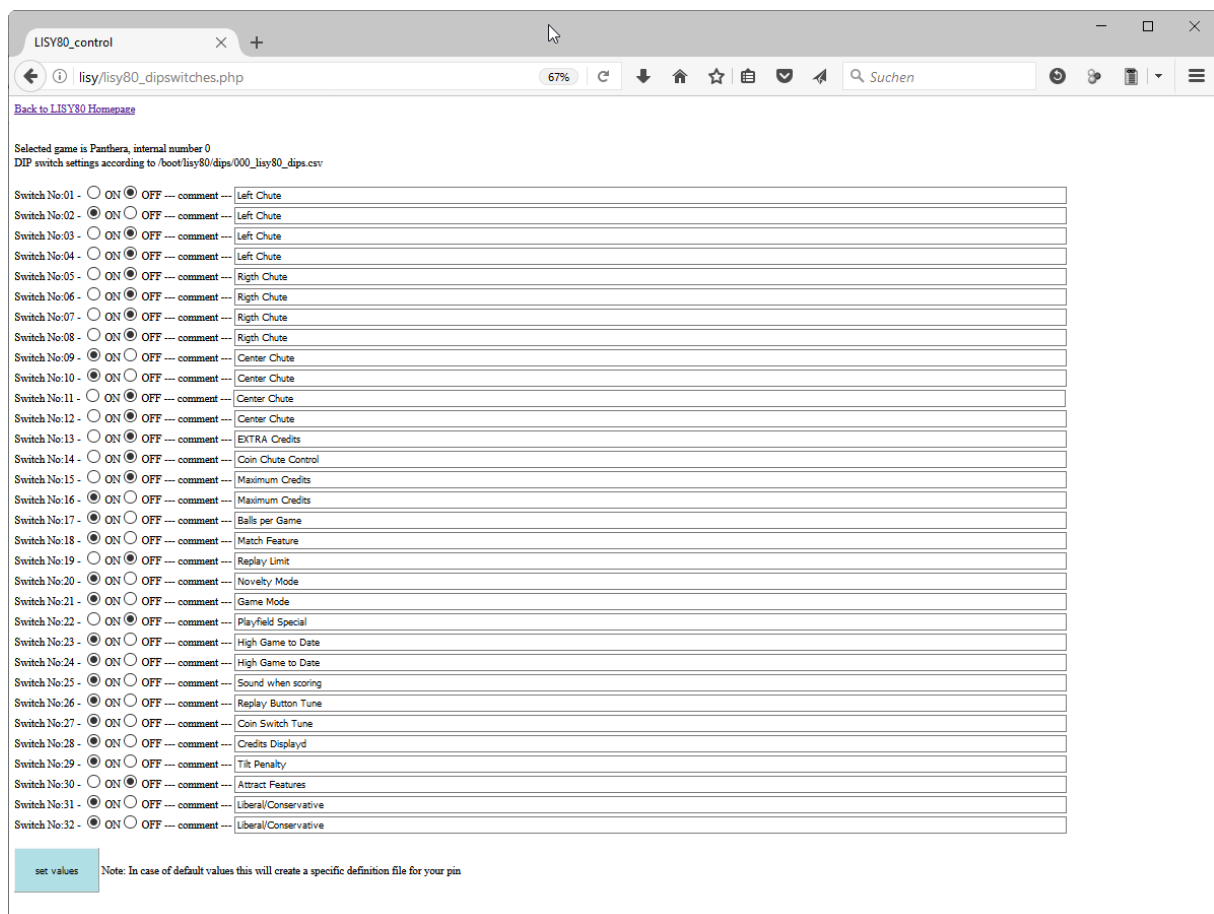

The screenshot shows a web browser window titled "LISY80_control" with the URL "lisy/lisy80_dipswitches.php". The page content includes a link to the LISY80 homepage, a message indicating the selected game is "Panthera" with internal number 0, and a list of 32 dip switches. Each switch is represented by a row with a label, a set of radio buttons for ON/OFF, a comment field, and a description field. The current settings for the switches are as follows:

Switch No.	ON	OFF	comment	Description
01	<input type="radio"/>	<input checked="" type="radio"/>		Left Chute
02	<input checked="" type="radio"/>	<input type="radio"/>		Left Chute
03	<input type="radio"/>	<input checked="" type="radio"/>		Left Chute
04	<input type="radio"/>	<input checked="" type="radio"/>		Left Chute
05	<input type="radio"/>	<input checked="" type="radio"/>		Rigth Chute
06	<input type="radio"/>	<input checked="" type="radio"/>		Rigth Chute
07	<input type="radio"/>	<input checked="" type="radio"/>		Rigth Chute
08	<input type="radio"/>	<input checked="" type="radio"/>		Rigth Chute
09	<input checked="" type="radio"/>	<input type="radio"/>		Center Chute
10	<input checked="" type="radio"/>	<input type="radio"/>		Center Chute
11	<input type="radio"/>	<input checked="" type="radio"/>		Center Chute
12	<input type="radio"/>	<input checked="" type="radio"/>		Center Chute
13	<input type="radio"/>	<input checked="" type="radio"/>		EXTRA Credits
14	<input type="radio"/>	<input checked="" type="radio"/>		Coin Chute Control
15	<input type="radio"/>	<input checked="" type="radio"/>		Maximum Credits
16	<input checked="" type="radio"/>	<input type="radio"/>		Maximum Credits
17	<input checked="" type="radio"/>	<input type="radio"/>		Balls per Game
18	<input checked="" type="radio"/>	<input type="radio"/>		Match Feature
19	<input type="radio"/>	<input checked="" type="radio"/>		Replay Limit
20	<input checked="" type="radio"/>	<input type="radio"/>		Novelty Mode
21	<input checked="" type="radio"/>	<input type="radio"/>		Game Mode
22	<input type="radio"/>	<input checked="" type="radio"/>		Playfield Special
23	<input checked="" type="radio"/>	<input type="radio"/>		High Game to Date
24	<input checked="" type="radio"/>	<input type="radio"/>		High Game to Date
25	<input checked="" type="radio"/>	<input type="radio"/>		Sound when scoring
26	<input checked="" type="radio"/>	<input type="radio"/>		Replay Button Tune
27	<input checked="" type="radio"/>	<input type="radio"/>		Coin Switch Tune
28	<input checked="" type="radio"/>	<input type="radio"/>		Credits Displayd
29	<input checked="" type="radio"/>	<input type="radio"/>		Tilt Penalty
30	<input type="radio"/>	<input checked="" type="radio"/>		Attract Features
31	<input checked="" type="radio"/>	<input type="radio"/>		Liberal/Conservative
32	<input checked="" type="radio"/>	<input type="radio"/>		Liberal/Conservative

At the bottom of the page, there is a "set values" button and a note: "Note: In case of default values this will create a specific definition file for your pin".

10.8. Sound

Test your sounds. By pushing the button the selected sound will be played. Only one sound can be played at a time. Sound 0 means 'no sound' (default)

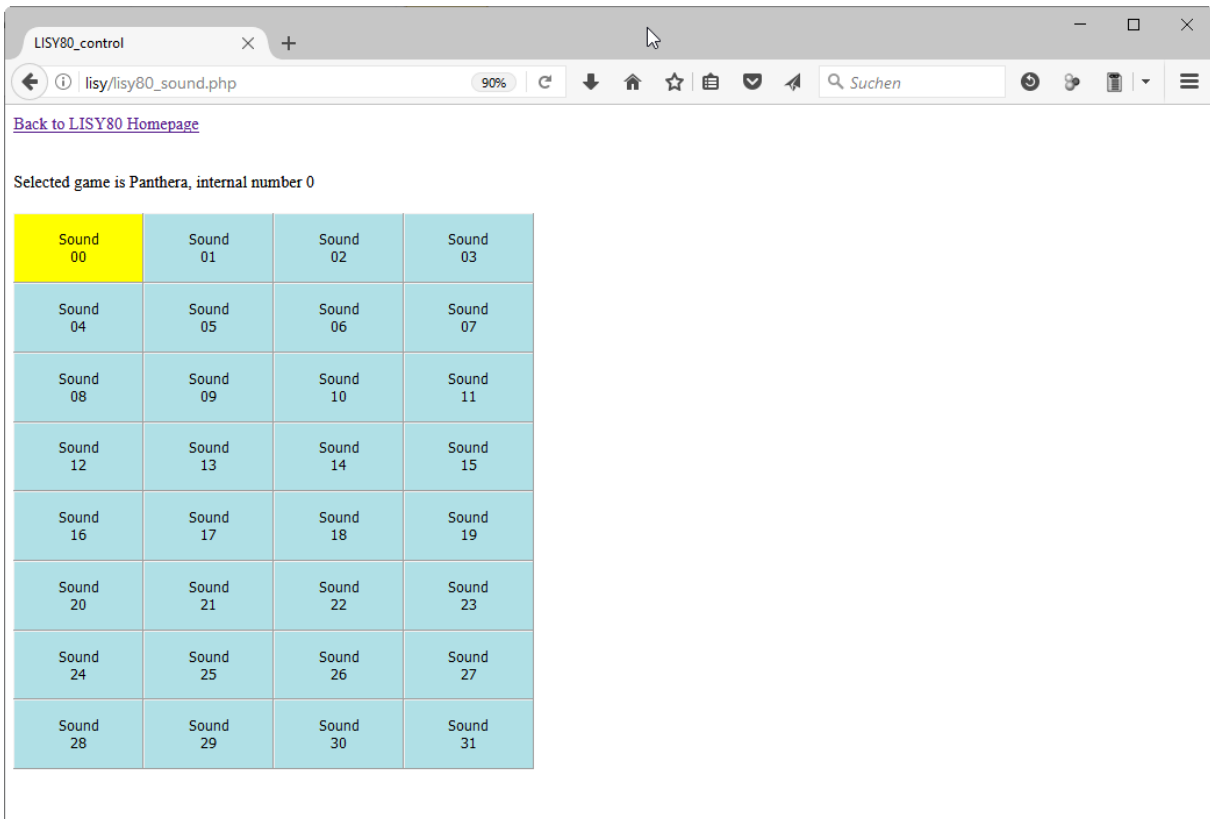

10.9. NVRAM information

LISY uses an 'eeprom' to store some statistic data, with this it can be displayed.

10.10. Software installed

Show (HW) Version of the LISY Board

10.11. Set hostname of the system

The default hostname of the system is 'lisy'. With this you can configure the hostname to any string you want. This can be useful if you have more than one LISY board

10.12. Initiate update of the system

Usually you will write a whole new SD card when updating the system. With this point small updates can be done without loading/writing the whole image. Updates will be announced on lisy80.com webpage if needed.

10.13. Upload new lamp, coil or switch configuration files

In case you do not want it to do with writing onto the SD card via windows.

11. Fadecandy

With LISY version 4.08+ controlling LEDs via Fadecandy is supported. Fadecandy works with the popular WS2811/WS2812 LEDs. Each controller board supports up to 512 LEDs, arranged as 8 strips of 64 each. More information can be found here <https://www.adafruit.com/product/1689> and here <https://github.com/scanlime/fadecandy>.

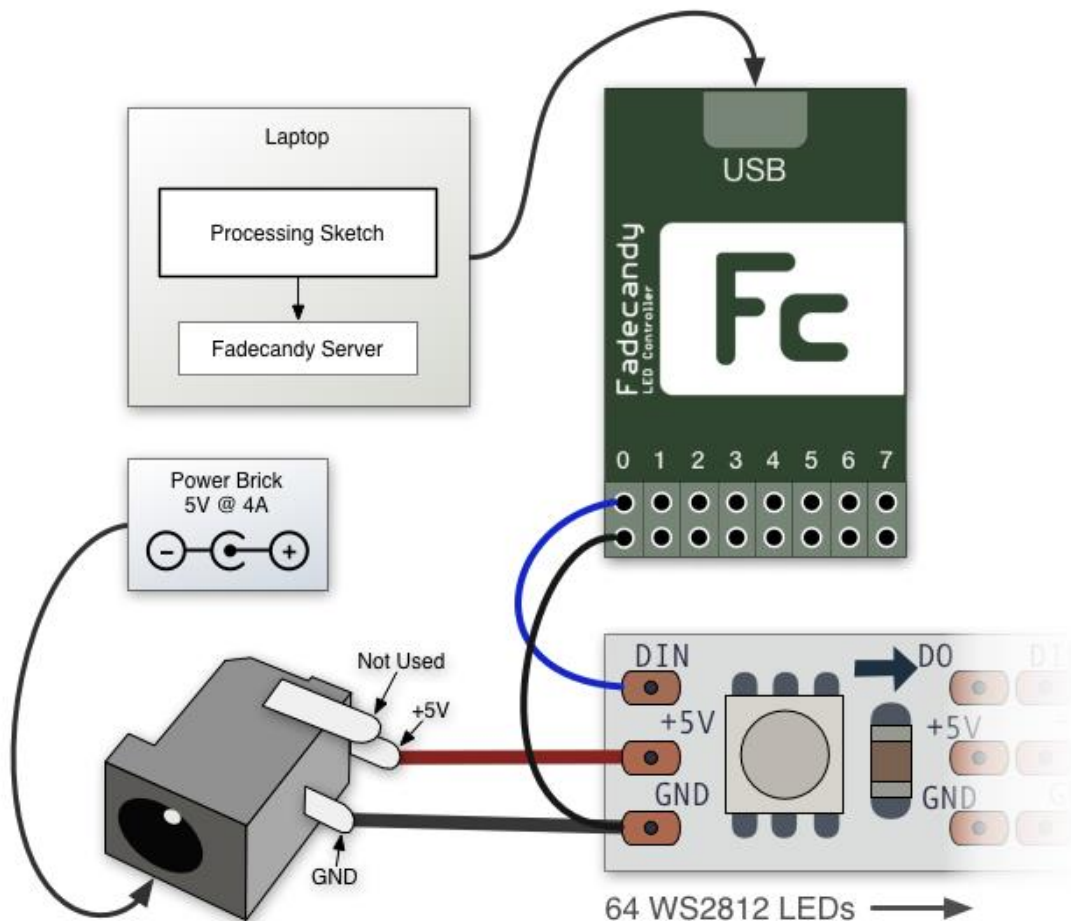

11.1. Hardware

You will need the Fadecandy board which can be purchased at Adafruit or at Digikey.

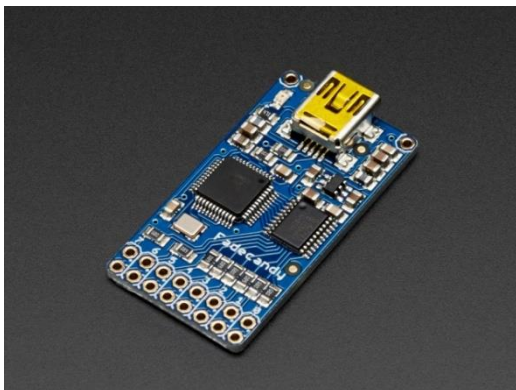

Fadecandy

In addition you need an additional 5 Volt power supply like this one (5 Volt / 12 Ampere)



Calculate 60 mA for each LED you want to control. Meaning with the power supply above you can supply up to 200 LEDs.

11.2. Settings on LISY board

By selecting Jumper K3 on the upper side LISY will try to connect to the 'fadecandy' Hardware.

11.3. Software, files to edit and/or add

The config file for fadecandy server (fcserver) is located under /lisy/lisy.json.

Here you can set general LED numbering, the whitepoint (set to 50% by default) and more. Please refer to the fcserver documentation on the fadecandy site for more details.

For each LED you can define the RGB value, if it is assigned to the GI or to controlled lamps.

In case of controlled lamps you can define which lamp is assigned and if the lamp should be driven in parallel. See appendix for example config files.

The assignments are configurable via the file '<NNN>_lisy1_fadecandy_GI.csv' & '<NNN>_lisy1_fadecandy_lamps.csv' (folder /lisy1/fadecandy) for a system1 machine; respective '<NNN>_lisy80_fadecandy_GI.csv' & '<NNN>_lisy80_fadecandy_lamps.csv' (folder /lisy80/fadecandy) for a system80 machine.

With NNN as the internal number of your Gottlieb game according, with leading zeros if it's shorter than three digits, to appendix A for Lisy1 or appendix B for Lisy80.

12. Coil Options

For coils LISY offer an optional config file to adjust the 'pulsetime' of individual coils.

12.1. Pulse time mod for LISY1 coils

/boot/lisy1/coils/xxx_lisy1_coils.csv

12.2. Pulse time mod for LISY80 coils

/boot/lisy80/coils/xxx_lisy80_coils.csv

13. Option sound (BETA)

With LISY version 4.07 or higher two sound modes are supported. The first uses the original sound emulation from pinmame, with the second it is possible to play its own 'wav-files' directly from the SD on the LISY board.

Switch S1								Mode
S1	S2	S3	S4	S5	S6	S7	S8	
*	on	*	off	*	off	*	off	Internal Sound (WAV - Files)
*	on	*	off	*	on	*	off	Pinmame Sound emulation

Even LISY uses an external soundcard, it has to be said that the pinmame sound emulation depends on the used game and need to be optimized. You can give it a try for your pinball machine but you may notice poor sounds, speed variances and 'clicking' between sounds.

13.1. Hardware

The LISYimage supports the 'Justboom Amp zero pHat' Sound Card, but any pHat compatible soundcard which works with the PI Zero can be used. By using another soundcard the config file 'config.txt' on the SD card needs to be edited. See excerpt from config.txt below

```
# and load the driver for the justboom soundcard
dtoverlay=justboom-dac
# for hifiberry and compatible ones ( e.g Speaker PHAT ) load this one
# dtoverlay=hifiberry-dac
```

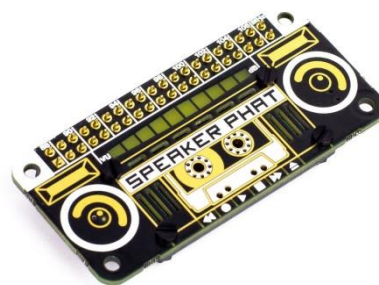

Justboom Soundcard & Speaker PHAT

Solder the Sound Option 1 to your LISY1/LISY80 and add an extra wire from the Soundcard to the speakers and disconnect the original connection. With this the volume setting is done with the potentiometer on the LISY board. With Sound Option 2 you can also use an external potentiometer, however you will need to add an extra wire also for that.

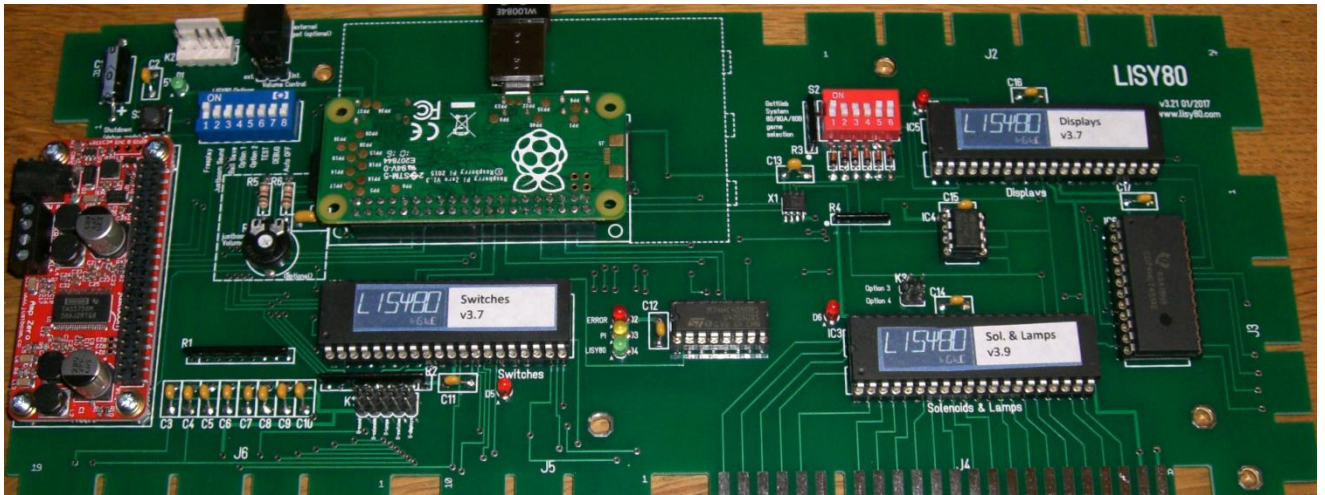

LISY80, with Sound Option 1&2 and a 'Justboom Soundcard'

13.2. Software, files to edit and/or add

For piname sound emulation at the moment no configurations are possible. Later versions will support editing the 'virtual switches' on the soundcard via LISYcontrol or 'csv-file'.

13.2.1. LISY1

Gottlieb system1 games can only play 5 tones, you can map each of these tones to a .wav file of your choice. For LISY1 files the names for the 5 files are fix, and mapped to the usual 10, 100, 100 scoring tones. In addition a file for 'tilt' and 'game over' can be mapped. The wav files need to be placed into the directory `'/lisy1/sounds/xxx'` on the SD card, where 'xxx' is the number of your game which you want to be emulated (e.g. 005 for Charlies Angels, see Appendix A).

boot (E:) > lisy1 > sounds > 005				
Name	Änderungsdatum	Typ	Größe	
10.wav	16.05.2018 13:33	WAV-Datei	26 KB	
100.wav	16.05.2018 13:33	WAV-Datei	38 KB	
1000.wav	16.05.2018 13:33	WAV-Datei	41 KB	
gameover.wav	16.05.2018 13:33	WAV-Datei	35 KB	
tilt.wav	16.05.2018 13:33	WAV-Datei	27 KB	

LISY1 example sound files for a system1 Charlies Angels

13.2.2. LISY80

Gottlieb system80 games can play 30 tones, you can map each of these tones to a .wav file of your choice. For LISY80 files the names for the 30 files are fix and numbered from 1..15 and 17..31 (there is no soundnumber 16). The wav files need to be placed into the directory `'/lisy80/sounds/xxx'` on the SD card, where 'xxx' is the number of your game which you want to be emulated (e.g. 010 for Mars, see Appendix B). In addition to that you need to create a configfile (xxx_lisy80_sounds.csv) in which you configure if the sound can be interrupted by other sounds or not.

This is done by the second field. A zero (0) means that the sound will not be interrupted by other sounds, this is useful for longer sounds and/or speech. The other fields are for future use and will not be interpreted!

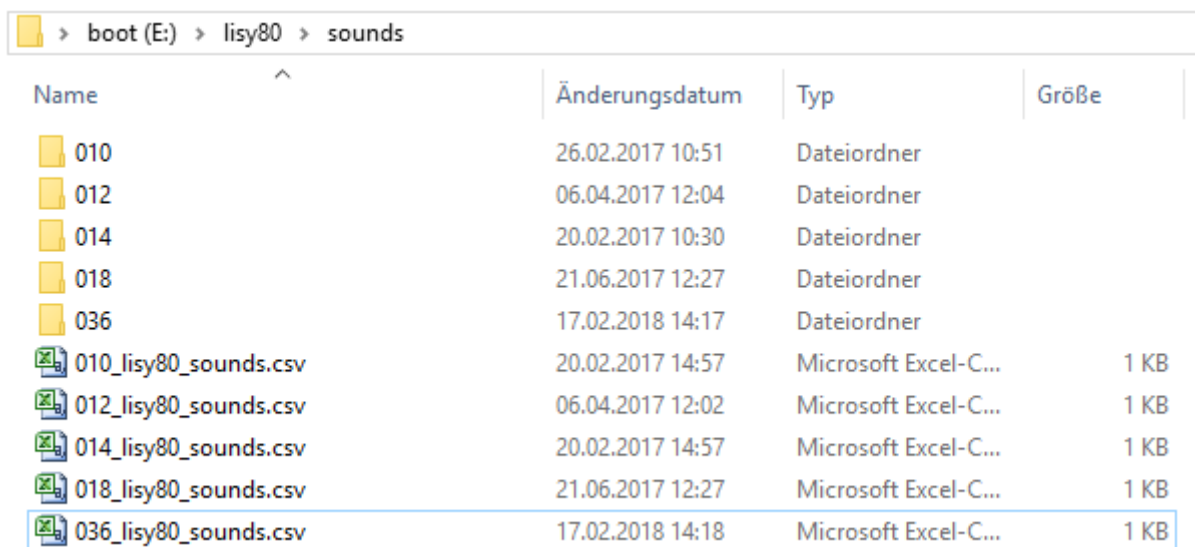

Name	Änderungsdatum	Typ	Größe
010	26.02.2017 10:51	Dateiordner	
012	06.04.2017 12:04	Dateiordner	
014	20.02.2017 10:30	Dateiordner	
018	21.06.2017 12:27	Dateiordner	
036	17.02.2018 14:17	Dateiordner	
010_lisy80_sounds.csv	20.02.2017 14:57	Microsoft Excel-C...	1 KB
012_lisy80_sounds.csv	06.04.2017 12:02	Microsoft Excel-C...	1 KB
014_lisy80_sounds.csv	20.02.2017 14:57	Microsoft Excel-C...	1 KB
018_lisy80_sounds.csv	21.06.2017 12:27	Microsoft Excel-C...	1 KB
036_lisy80_sounds.csv	17.02.2018 14:18	Microsoft Excel-C...	1 KB

LISY80 example config files & directories for Mars, Volcano, Black Hole, Devils Dare & Eldorado

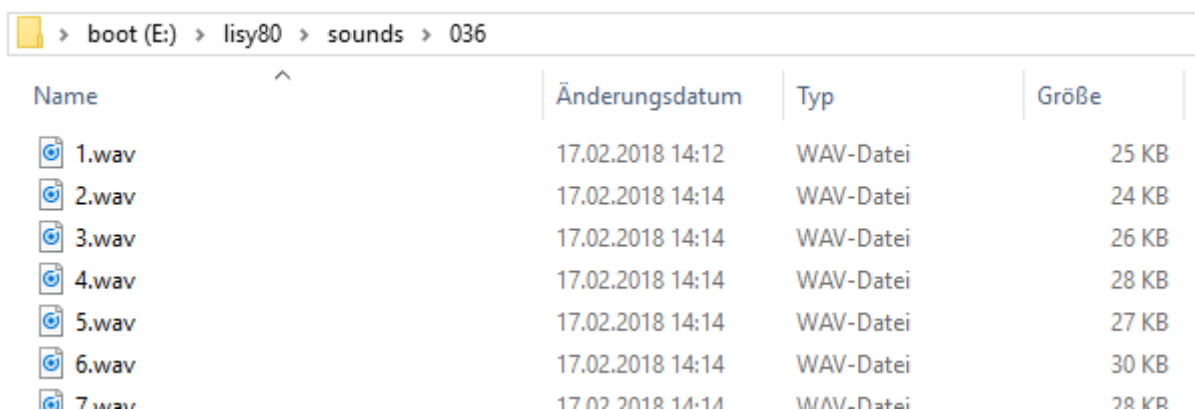

Name	Änderungsdatum	Typ	Größe
1.wav	17.02.2018 14:12	WAV-Datei	25 KB
2.wav	17.02.2018 14:14	WAV-Datei	24 KB
3.wav	17.02.2018 14:14	WAV-Datei	26 KB
4.wav	17.02.2018 14:14	WAV-Datei	28 KB
5.wav	17.02.2018 14:14	WAV-Datei	27 KB
6.wav	17.02.2018 14:14	WAV-Datei	30 KB
7.wav	17.02.2018 14:14	WAV-Datei	28 KB

LISY80 example sound files for a system80B eldorado

Sound	can_be_interrupted	loop	store & catch up	comment	Black Hole
1	0	0	0		
2	1	0	0		
3	0	0	0	Tilt Tilt Tilt	
4	1	0	0		
5	1	0	0		
6	1	0	0		
7	1	0	0		
8	1	0	0		
9	1	0	0		
10	1	0	0		
11	1	0	0		
12	1	1	0		
13	1	0	0		
14	1	0	0		
15	0	0	0	Oh nooo	
16	1	0	0	not used	
17	1	0	0		
18	1	0	0		
19	1	0	0		
20	1	0	0		
21	1	1	0		
22	1	1	0		
23	0	0	0	shoot captive hole	
24	0	0	0	complete bank for reentry	
25	0	0	0	enter gravity tunnel	
26	0	0	0	reentry attempt has failed	
27	0	0	0	reentry accomplished	
28	0	0	0	extra ball lit	
29	0	0	0	shoot for special	
30	0	0	0	gforce accelerated	
31	0	0	0	captured	

LISY80 example configuration file '014_lisy80_sounds.csv' for a Black Hole

14. Option '7 digit'

LISY supports the use of '7digit' displays.

With LISY80 (System80) this is done via the pinname roms created by Oliver.

For LISY1 (System1) this is done internally by LISY using the original roms.

This option can be switched on with Dip3 of Switch S1

Switch S1								Mode
S1	S2	S3	S4	S5	S6	S7	S8	
x	x	on	x	off	off	x	off	7digit mode

14.1. LISY1

Can be used with all System1 games together with the original pinname romset. Modification will be done internally in LISY.

14.1.1. Needed Hardware modification

TBD

14.2. LISY80

This option can only be used with System80 games. System80A games have 7 digit displays anyway and System80B games have complete different displays. By setting Dip3 to 'on' LISY will use the rom config file `./lisy80/cfg/lisy80games_7digit.csv` instead of config file `./lisy80/cfg/lisy80games.csv`

See Appendix for details, especially the names of the rom images you need to put in the `./lisy80/roms` folder.

14.2.1. Needed Hardware modification

A good description what you need to do can be found here:

<https://pinside.com/pinball/forum/topic/convertng-any-system-80-6-digit-gottlieb-to-80a-7-digit>

and here (French)

<https://www.flipperfrance.com/threads/7-digits-kit-adaptation.12361/>

15. Image

The image is based on Raspberry ‚Jessie‘. There are two configured user:

User : ‚pi‘, Password : ‚lisy80‘

User : ‚root‘, Password: ‚bontango‘

One partition (the ‚/boot‘ partition) is formatted in ‚Vfat‘. Because of this you can read and write it with the help of a SD card reader for example under windows. With this you can adapt the different configuration files according to your needs/hardware.

The main sections are the same for LISY1 and LISY80; sitting either under /boot/lisy1 or /boot/lisy80.

Note: Within windows you will not see the ‚/boot/..‘ path as there you can only read the vfat partition. There you just see /lisy1 respective /lisy80 folders.

Folder ./debug/; files lisy1_debug.txt or lisy80_debug.txt -> debug files, automatically created if you start your LISY in debug mode.

./cfg/lisy80games.csv or lisy1games.csv -> list of supported Gottlieb games

15.1. Wireless config

At least for the internal webserver (LISYcontrol) you may want to have your system connected to your local network. LISY supports two modes: client mode & host mode; where client mode is the default mode.

15.1.1. Client mode

In client mode LISY will try to connect to your local (wireless) network.

In the image wireless is preconfigured with the following settings

```
WLAN ID : "LISY80"
```

```
Password : "EnErgie80"
```

You may want to configure this file to fit with your local (home) settings and can

Do that by editing file ‚/lisy/lisy/ wpa_supplicant.conf‘ on the SD card.

Per default, this file looks as following

```
ctrl_interface=DIR=/var/run/wpa_supplicant GROUP=netdev
update_config=1
country=DE
network={
    ssid="LISY80"
```

```
    psk="EnErgie80"  
}
```

Only edit the lines `ssid="LISY80"` and `psk="EnErgie80"` by replacing *LISY80* with your own Wireless Lan ID and *EnErgie80* with your password.

15.1.2. hotspot mode

In hotspot mode, LISY will provide a wireless hotspot to be able to easily connect with your mobile phone or pad. For selecting host mode

After starting LISY you should be able to identify a new wireless network.

The network ID : `'LISY_Control'`

The keyphrase : `'lisy80_and_lisy1_rocks'`.

After successfully connected to this network, you can reach the LISY_control webserver by connecting to the IP address 192.168.80.1

Config files for hostmode are `'hostapd.conf'` and `'dnsmasq'` and can be found in folder `'/lisy/lisy'` on the vfat section of the SD-Card.

15.2. Files in `/boot/lisy1/roms` & `/boot/lisy80/roms`

Here you have to put in your Gottlieb rom images (zip-format). **Due to copyright reasons, the image does not contain any Gottlieb rom code.** See appendix A or appendix B in order to select the right name/format for your specific game.

15.3. Files in `/boot/lisy1/dips` & `/boot/lisy80/dips`

Here you put your dip settings in a csv file to adjust the 'behavior' of your games. Settings are according your pinball manual.

See section LISYcontrol / dip settings for an explanation of this.

See Appendix B for a list of default settings.

15.4. Serial connection

Via ,K2' the serial signals TxD & RxD of the raspberry Raspberry Pi can be connected.

Please note that these signals are 3.3 Volt and cannot be connected to a standard serial connector of e.g. a windows PC without doing damage to your PI.

However you can use a level converter and access the system e.g. with 'putty' using the following settings:

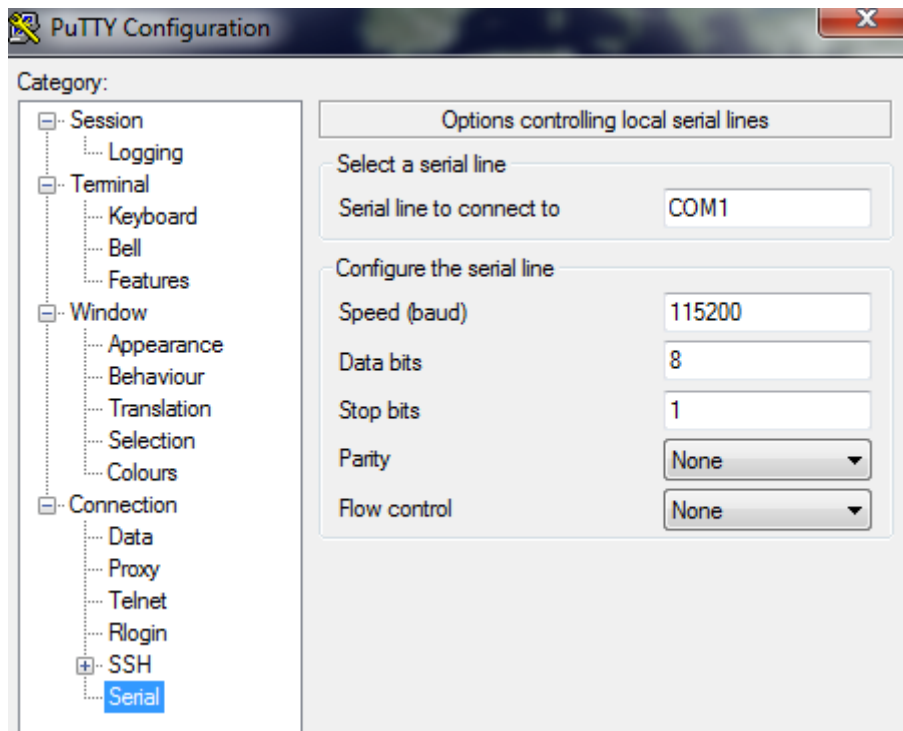

16. LISY and MPF ,Mission Pinball Framework‘

With Version 4.x LISY Support Mission Pinball Framework.

From the website <http://missionpinball.org/>

The **Mission Pinball Framework** (“MPF”) is a free Python-based pinball software framework that’s used to run real pinball machines. It allows both casual builders and hard-core programmers to create the software to run their pinball machines—whether it’s new game code for an existing pinball machine, a “re-theme” of an old machine, or totally custom / homebrew machine built from scratch.

MPF is cross-platform and runs on Windows, Mac, Linux, and the Raspberry Pi. It’s available in 32-bit and 64-bit versions and can be installed in minutes.

The LISY image support two modes, ‘slave mode’ and ‘master mode’. Usually while creating/developing a configuration for a given pinball machine, one will use the LISY ‘slave mode’. With this MPF is running on an external host and connected either via IP or direct USB cable to the Raspberry Pi running LISY. With this it is easy to develop and test the MPF configuration file. Once finalized the configuration can be transferred to the SD card of the Raspberry Pi and switched to ‘master mode’. In master mode MPF runs on the raspberry PI together with LISY, eliminating the need for an external host.

(Note: due to limited performance, only MPF can be run on the PI, not the Media Controller ‘MPF-MC’)

16.1. Connection in ,master mode‘

If you’re using the “master” mode where MPF runs on the LISY board itself, you need to get your MPF config installed onto the LISY board. You can do this via the SD card.

Place your MPF config in the folder `/boot/mpfcfg/lisyx/yyy/` on the SD Card (replace “x” with 1 for LISY1 and with “80” for LISY80. Replace “yyy” with your game number with leading zeros if it’s shorter than three digits). For instance with *Dare Devil*, the game would be at `/boot/mpfcfg/LISY80/018/` on the SD card.

16.2. Connection in ,slave mode‘ (serial)

Connection to LISY can be made via IP or via direct USB connection. For the USB connection no special driver Software nor a special USB cable is needed, a ‘normal’ USB charging cable (USB Micro cable) will do the job. Once connected to the Host Computer (hopefully) will identify a new serial device, usually ‘COM3’ under windows or ‘/dev/ttyACM0’ under Linux.

Windows 10 screenshot hardware, device is COM3

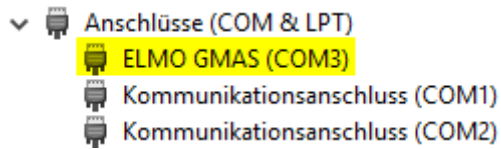

```
config.yaml:
```

```
hardware:
```

```
  platform: lisy
```

```
lisy:
```

```
  connection: serial
```

```
  port: com3
```

```
  baud: 115200
```

Example: Linux (Ubuntu) 'dmesg' output, device is /dev/ttyACM0

```
usb 1-3: new high-speed USB device number 11 using ehci-pci
```

```
usb 1-3: New USB device found, idVendor=0525, idProduct=a4a7
```

```
usb 1-3: New USB device strings: Mfr=1, Product=2, SerialNumber=0
```

```
usb 1-3: Product: Gadget Serial v2.4
```

```
usb 1-3: Manufacturer: Linux 4.4.50+ with 20980000.usb
```

```
cdc_acm 1-3:2.0: ttyACM0: USB ACM device
```

```
usbcore: registered new interface driver cdc_acm
```

```
cdc_acm: USB Abstract Control Model driver for USB modems and ISDN adapters
```

```
config.yaml
```

```
hardware:
```

```
platform: lisy

lisy:
  connection: serial
  port: /dev/ttyACM0
  baud: 115200
```

16.3. Connection in ,slave mode' (IP)

LISY is listening on port '5963' on all available interfaces

```
Config.yaml:

hardware:
  platform: lisy

lisy:
  connection: network
  network_port: 5963
  network_host: lisy
```

LISY is configured to get its IP address by DHCP, the default hostname is 'lisy'. For WLAN your WLAN-Id and Password can be put into a text file on the SD-card. LISY will show the IP address on the first two displays of the pinball during boot time. (or 'NO IP' if no IP address could be found).

16.4. Jumper settings on LISY board

As usual set your dip switches of Switch 'S2' according to your hardware (pinball machine). See Appendix A and B for details.

With switch 'S1' you can select either slave or master mode.

Switch S1								Mode
S1	S2	S3	S4	S5	S6	S7	S8	
off	off	off	on	off	off	off	on	MPF Master Mode
off	off	off	on	off	on	off	on	MPF Slave Mode (serial)
off	off	on	on	off	on	off	on	MPF Slave Mode (network)

The dip switch settings are only interpreted at boot time, so if you want to switch between master & slave mode you have to reboot the Raspberry PI. For doing that it is safe to just to switch 'off' and the switch 'on' the pinball machine, as the LISY image is 'read only'.

Note: If you are using a USB connection you have also to disconnect this one in order to be able to reboot, as with a powered up Host the Raspberry PI will be powered by the USB connection.

16.5. Special configuration statements

16.5.1. Using lamp driver as coils (LISY1 & LISY80)

As Gottlieb was 'running out' on coil drivers in later games they used lamp drivers with an 'extra transistor' to solve that problem. In MPF these 'lamps' need to be controlled in the same way as coils. For LISY1 & LISY80 you can define a lamp as a coil by adding '100' to the lamp number.

Example for 'config.yaml'

coils:

```
c_trough_release: # trough is a 'lamp' (L12), so we add 100 to the number  
number: 112
```

This is for Gottlieb Devils Dare, in this game the ball release coil is controlled by lamp driver #12. So the 'virtual' coil 'c_trough_release' is defined with number 112 (100 + 12).

16.5.2. Switches with LISY1

LISY1 supports the System 1 switch matrix which consists of a maximum of 40 switches, the switch number in the Manual can be used within mpf. However some of the switches in Gottlieb System1 games are NOT part of the switch matrix. These are the outhole switch, the SLAM switch and the 'RESET' switch on the board itself. The mpfserver for LISY1 is numbering these switches in the same way as pinname does it:

SLAM: #76

Outhole: #66

Reset: #56

Note: As the SLAM switch is usually closed, the logic is 'reversed' here. A closed SLAM switch is interpreted as open within mpfserver.

16.5.3. Switches with LISY80

LISY80 supports the System 80 switch matrix which consists of a maximum of 64 switches, the switch number in the Manual can be used within mpf.

You may not find all switches in your game manual as some switches are equal along all System80/80A/80B games and Gottlieb there for decided not to document them ;-)

These switches are (taken from pinwiki.com):

06 - left advance button (Sys80B only)

07 - play / test switch



16 - right advance button (Sys80B only)

- 17 - left coin switch
- 27 - right coin switch
- 37 - center coin switch
- 47 - replay button
- 57 - plumb bob and ball roll tilts (these have the same switch assignment as the playfield tilt switch)

Note: The SLAM switch in system80, which is NOT part of the switch matrix, cannot be used in mpfserver for LISY80 in the current release.

16.5.4. sounds

Soundfiles need to be placed in the mpf config directory **on the SD card of the LISY** system in the subdirectory 'hardware_sounds' For LISY1 this is '/boot/mpfcfg/LISY1/xxx' and for LISY80 this is '/boot/mpfcfg/LISY80/xxx', where xxx is the game number set via S2 according to the appendix.

boot (E:) > mpfcfg > LISY1 > 005 > hardware_sounds			
Name	Änderungsdatum	Typ	Größe
 My Name is Charlie.mp3	20.05.2018 14:06	MP3-Datei	28 KB
 theme.mp3	29.04.2018 10:07	MP3-Datei	1.003 KB

Example sound config for a system1 Charlies Angels (game number 5)

Example mpf config:

```
hardware_sound_systems:
  default:
    label: LISY

hardware_sound_player:
  test2:
    2:
      action: play
  play_file:
    "some_file": play_file
  play_file_loop:
    "some_file":
      action: play_file
      platform_options:
        loop: True
        no_cache: False
  play_text:
    text:
      action: text_to_speech
      value: "Hello MPF"
      platform_options:
        loop: False
```

```
        no_cache: True
volume_05:
  set_volume:
    action: set_volume
    value: 0.5
increase_volume:
  0.1: increase_volume
decrease_volume:
  decrease_volume:
    action: decrease_volume
    value: 0.01
test3:
  3: play
test_stop: stop
```

17. when things go wrong, LISY debug mode

LISY has a built in debug mode which can be switched on by dip7 of Switch S1. Messages will be shown via the standard serial interface (/dev/serial0) which is mapped to the system console and as well written to a debug text file on the SD Card.

Note: In debug mode the system runs in read/write mode (in 'normal mode' LISY runs in read-only mode). As the operating system is a standard Linux System switching off power without shutting down the system can damage your system files.

17.1. testing/debugging on the bench

For testing you **do not need** to install LISY to your pinball machine. Just power your Raspberry PI with a standard USB charger (2 Amp recommended); the Raspberry will power the LISY PCB.

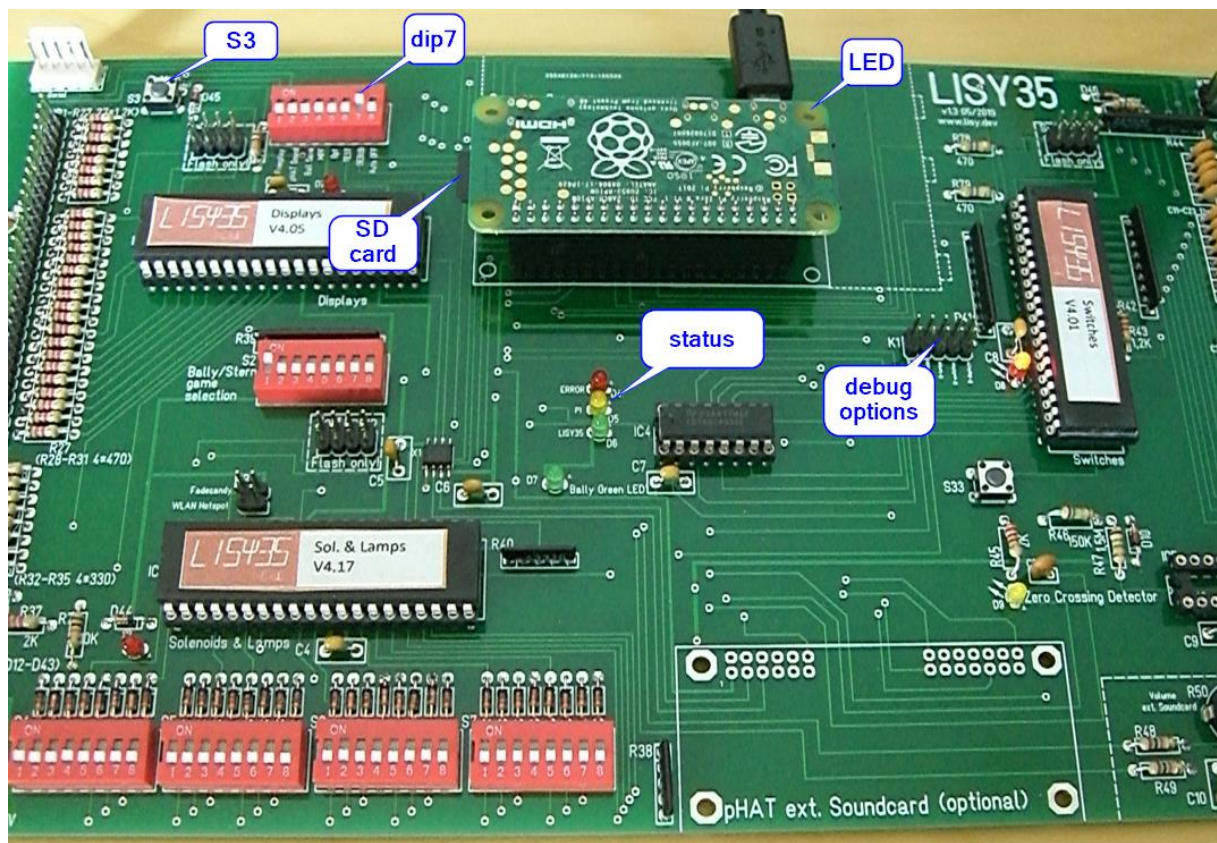

Picture: LISY35 'on the bench' in Debug Mode

17.2. Preconditions

You need at least a running Raspberry PI to be able to produce a debug file. Meaning by powering on LISY, after a few seconds the LED on the Raspberry PI should begin 'blinking' fast. If that not happens check your SD card and/or your Raspberry PI.

17.3. how to create a debug file

Set dip switch 7 (debug) to position ON, leave all other switches in their position. Power up your LISY card, either by putting it into your pinball or by using a standard USB charger (see section above how to do that.)

After a few seconds the LED on the Raspberry PI should start blinking and the yellow LED 'PI' will went on. Wait until your LISY runs into error, and push S3 afterwards. After pushing S3 the LED on the PI will start blinking again. Wait at least 20 seconds until the LED on the Raspberry will went off.

Powering off your LISY and take out the SD card.

Depending on the problem, either you will find output in file `"/lisy/lisy/debug/lisy_debug_hw.txt"` and/or in `"/lisy/lisy<n>/debug/lisy<n>_debug.txt"`, where 'n' is either 1,80, or 35.

17.4. debugging options

Debugging options can be selected with 'jumpers' on K1. You can combine as many debug outputs as you want, but have to be aware that the more debugging you do the more will the system slow down and debug files can get huge. Doing debugging with no jumpers at all will give 'basic debugging messages which is a good option to start with.

K1-Jumper 1-2:	detailed debugging messages for displays
K1-Jumper 3-4:	detailed debugging messages for switches
K1-Jumper 5-6:	detailed debugging messages for lampes (Q1..Q52)
K1-Jumper 7-8:	detailed debugging messages for solenoids (Solenoid 1..9)
K1-Jumper 9-10:	detailed debugging messages for sound (without S16 (Q10))

Appendix A ,Gamelist' LISY1

No	Dip Switch S3				Mame Name	Long Name
	S1	S2	S3	S4		
0	off	off	off	off	cleoptra	Cleopatra
1	on	off	off	off	sinbad	Sinbad
2	off	on	off	off	jokrpokr	Joker Poker
3	on	on	off	off	dragon	Dragon
4	off	off	on	off	closeenc	Close Encounters of the Third Kind
5	on	off	on	off	charlies	Charlie's Angels
6	off	on	on	off	solaride	Solar Ride
7	on	on	on	off	countdwn	Count-Down
8	off	off	off	on	pinpool	Pinball Pool
9	on	off	off	on	totem	Totem
10	off	on	off	on	hulk	The Incredible Hulk
11	on	on	off	on	genie	Genie
12	off	off	on	on	buckrgrs	Buck Rogers
13	on	off	on	on	torch	Torch
14	off	on	on	on	roldisco	Roller Disco
15	on	on	on	on	astannie	Asteroid Annie and the Aliens

Appendix B ,Gamelist' LISY80

No	Dip Switch S2						Mame Name	Type	Long Name	GTB NO
	S1	S2	S3	S4	S5	S6				
0	off	off	off	off	off	off	panthera	SYS80	Panthera	652
1	on	off	off	off	off	off	spidermn	SYS80	Spiderman	653
2	off	on	off	off	off	off	circus	SYS80	Circus	654
3	on	on	off	off	off	off	cntforce	SYS80	Counterforce	656
4	off	off	on	off	off	off	starrace	SYS80	Star Race	657
5	on	off	on	off	off	off	jamesb	SYS80	James Bond Timed Play	658
6	off	on	on	off	off	off	jamesb2	SYS80	James Bond 3/5-Ball	658
7	on	on	on	off	off	off	timeline	SYS80	Time Line	659
8	off	off	off	on	off	off	forceii	SYS80	Force II	661
9	on	off	off	on	off	off	pnkpnthr	SYS80	Pink Panther	664
10	off	on	off	on	off	off	mars	SYS80	Mars - God of War Speech	666
11	on	on	off	on	off	off	mars2	SYS80	Mars - God of War Soundonly	666
12	off	off	on	on	off	off	vlcno_ax	SYS80	Volcano speech rev4	667
13	on	off	on	on	off	off	vlcno_1b	SYS80	Volcano Soundonly	667
14	off	on	on	on	off	off	blckhole	SYS80	Black Hole	668
15	on	on	on	on	off	off	blkholea	SYS80	Black Hole Soundonly	668
16	off	off	off	off	on	off	hh	SYS80	Haunted House	669
17	on	off	off	off	on	off	eclipse	SYS80	Eclipse	671
18	off	on	off	off	on	off	dvlsdre	SYS80A	Devils DareSpeech	670
19	on	on	off	off	on	off	dvlsdre2	SYS80A	Devils Dare Soundonly	670
20	off	off	on	off	on	off	rocky	SYS80A	Rocky	672
21	on	off	on	off	on	off	spirit	SYS80A	Spirit	673
22	off	on	on	off	on	off	punk	SYS80A	Punk	674
23	on	on	on	off	on	off	striker	SYS80A	Striker	675
24	off	off	off	on	on	off	krull	SYS80A	Krull	676
25	on	off	off	on	on	off	qbquest	SYS80A	Q*Bert's Quest	677
26	off	on	off	on	on	off	sorbit	SYS80A	Super Orbit	680
27	on	on	off	on	on	off	rflshdx	SYS80A	Royal Flush Deluxe	681
28	off	off	on	on	on	off	goinnuts	SYS80A	Goin' Nuts	682
29	on	off	on	on	on	off	amazonh	SYS80A	Amazon Hunt	684
30	off	on	on	on	on	off	rackemup	SYS80A	Rack 'Em Up	685
31	on	on	on	on	on	off	rainfire	SYS80A	Ready...Aim...Fire!	686
32	off	off	off	off	off	on	jack2opn	SYS80A	Jacks To Open	687
33	on	off	off	off	off	on	touchdn	SYS80A	Touchdown	688
34	off	on	off	off	off	on	alienstr	SYS80A	Alien Star	689
35	on	on	off	off	off	on	thegames	SYS80A	The Games	691
36	off	off	on	off	off	on	eldorado	SYS80A	El Dorado City of Gold	692

37	on	off	on	off	off	on	icefever	SYS80A	Ice Fever	695
38	off	on	on	off	off	on	notused1	SYS80A	notused1	1
39	on	on	on	off	off	on	notused2	SYS80A	notused2	2
40	off	off	off	on	off	on	bountyh	SYS80B	Bounty Hunter	694
41	on	off	off	on	off	on	triplay	SYS80B	Chicago Cubs Triple Play	696
42	off	on	off	on	off	on	tagteam	SYS80B	Tag Team	698
43	on	on	off	on	off	on	rock	SYS80B	Rock	697
44	off	off	on	on	off	on	raven	SYS80B	Raven	702
45	on	off	on	on	off	on	rock_enc	SYS80B	Rock Encore	704
46	off	on	on	on	off	on	hlywoodh	SYS80B	Hollywood Heat	703
47	on	on	on	on	off	on	genesis	SYS80B	Genesis	705
48	off	off	off	off	on	on	goldwing	SYS80B	Gold Wings	707
49	on	off	off	off	on	on	mntecrlo	SYS80B	Monte Carlo	708
50	off	on	off	off	on	on	sprbreak	SYS80B	Spring Break	706
51	on	on	off	off	on	on	arena	SYS80B	Arena	709
52	off	off	on	off	on	on	victory	SYS80B	Victory	710
53	on	off	on	off	on	on	diamond	SYS80B	Diamond Lady	711
54	off	on	on	off	on	on	txsector	SYS80B	TX Sector	712
55	on	on	on	off	on	on	robowars	SYS80B	Robo War	714
56	off	off	off	on	on	on	excalibr	SYS80B	Excalibur	715
57	on	off	off	on	on	on	badgirls	SYS80B	Bad Girls	717
58	off	on	off	on	on	on	bighouse	SYS80B	Big House	713
59	on	on	off	on	on	on	hotshots	SYS80B	Hot Shots	718
60	off	off	on	on	on	on	bonebstr	SYS80B	Bone Busters Inc.	719
61	on	off	on	on	on	on	nmoves	SYS80B	Night Moves	C-103
62	off	on	on	on	on	on	notused3	SYS80B	notused3	3
63	on	on	on	on	on	on	notused4	SYS80B	notused4	4

Appendix C ,Gamelist' LISY80 7digit

No	Dip Switch S3						Mame Name	Type	Long Name	GTB NO
	S1	S2	S3	S4	S5	S6				
0	off	off	off	off	off	off	panther7	SYS80	Panthera	652
1	on	off	off	off	off	off	spiderm7	SYS80	Spiderman	653
2	off	on	off	off	off	off	circus7	SYS80	Circus	654
3	on	on	off	off	off	off	cntforc7	SYS80	Counterforce	656
4	off	off	on	off	off	off	starrac7	SYS80	Star Race	657
5	on	off	on	off	off	off	jamesb7	SYS80	James Bond Timed Play	658
6	off	on	on	off	off	off	jamesb7b	SYS80	James Bond 3/5-Ball	658
7	on	on	on	off	off	off	timelin7	SYS80	Time Line	659
8	off	off	off	on	off	off	forceii7	SYS80	Force II	661
9	on	off	off	on	off	off	pnkpntr7	SYS80	Pink Panther	664
10	off	on	off	on	off	off	mars7	SYS80	Mars - God of War Speech	666
11	on	on	off	on	off	off	mars2	SYS80	Mars - God of War Soundonly	666
12	off	off	on	on	off	off	vlcno_a7	SYS80	Volcano speech rev4	667
13	on	off	on	on	off	off	vlcno_b7	SYS80	Volcano Soundonly	667
14	off	on	on	on	off	off	blkhole7	SYS80	Black Hole	668
15	on	on	on	on	off	off	blkhol7s	SYS80	Black Hole Soundonly	668
16	off	off	off	off	on	off	hh7	SYS80	Haunted House	669
17	on	off	off	off	on	off	eclipse7	SYS80	Eclipse	671

Appendix D ,Gamelist' LISY35

No	S1	S2	S3	S4	S5	S6	S7	S8	Mame Name	Long Name
0	off	off	off	off	off	off	off	off	freedom	Freedom
1	on	off	off	off	off	off	off	off	nightrdr	Night Rider (rev. 21)
2	off	on	off	off	off	off	off	off	evelknie	Evel Knievel
3	on	on	off	off	off	off	off	off	eightbll	Eight Ball
4	off	off	on	off	off	off	off	off	pwerplay	Power Play
5	on	off	on	off	off	off	off	off	matahari	Mata Hari
6	off	on	on	off	off	off	off	off	stk_sprs	Strikes and Spares
7	on	on	on	off	off	off	off	off	blackjck	Black Jack
8	off	off	off	on	off	off	off	off	lostwrld	Lost World
9	on	off	off	on	off	off	off	off	smman	The Six Million Dollar Man
10	off	on	off	on	off	off	off	off	playboy	Playboy
11	on	on	off	on	off	off	off	off	voltan	Voltan Escapes Cosmic Doom
12	off	off	on	on	off	off	off	off	sst	Supersonic
13	on	off	on	on	off	off	off	off	startrek	Star Trek
14	off	on	on	on	off	off	off	off	paragon	Paragon
15	on	on	on	on	off	off	off	off	hglbtrtr	Harlem Globetrotters
16	off	off	off	off	on	off	off	off	dollyptn	Dolly Parton
17	on	off	off	off	on	off	off	off	kiss	Kiss
18	off	on	off	off	on	off	off	off	futurspa	Future Spa
19	on	on	off	off	on	off	off	off	spaceinv	Space Invaders
20	off	off	on	off	on	off	off	off	ngndshkr	Nitro Groundshaker
21	on	off	on	off	on	off	off	off	slbmania	Silverball Mania
22	off	on	on	off	on	off	off	off	rollston	Rolling Stones
23	on	on	on	off	on	off	off	off	mystic	Mystic
24	off	off	off	on	on	off	off	off	hotdoggn	Hot Doggin
25	on	off	off	on	on	off	off	off	viking	Viking
26	off	on	off	on	on	off	off	off	skatebll	Skateball
27	on	on	off	on	on	off	off	off	frontier	Frontier
28	off	off	on	on	on	off	off	off	xenon	Xenon
29	on	off	on	on	on	off	off	off	flashgdn	Flash Gordon
30	off	on	on	on	on	off	off	off	eballdlx	Eight Ball Deluxe (rev. 15)
31	on	on	on	on	on	off	off	off	fball_ii	Fireball II
32	off	off	off	off	off	on	off	off	embryon	Embryon
33	on	off	off	off	off	on	off	off	fathom	Fathom
34	off	on	off	off	off	on	off	off	medusa	Medusa
35	on	on	off	off	off	on	off	off	centaur	Centaur
36	off	off	on	off	off	on	off	off	elektra	Elektra
37	on	off	on	off	off	on	off	off	vector	Vector
38	off	on	on	off	off	on	off	off	spectrum	Spectrum

39	on	on	on	off	off	on	off	off	speakesy	Speakeasy
40	off	off	off	on	off	on	off	off	speake2	Speakeasy (2 Player)
41	on	off	off	on	off	on	off	off	rapidfir	Rapid Fire
42	off	on	off	on	off	on	off	off	m_mpac	Mr. & Mrs. Pac-Man Pinball
43	on	on	off	on	off	on	off	off	bmw	BMX
44	off	off	on	on	off	on	off	off	granslam	Grand Slam
45	on	off	on	on	off	on	off	off	gransla2	Grand Slam (2 Player)
46	off	on	on	on	off	on	off	off	goldball	Gold Ball
47	on	on	on	on	off	on	off	off	xsandos	X's & O's
48	off	off	off	off	on	on	off	off	kosteel	Kings of Steel
49	on	off	off	off	on	on	off	off	blakpyra	Black Pyramid
50	off	on	off	off	on	on	off	off	spyhuntr	Spy Hunter
51	on	on	off	off	on	on	off	off	fbclass	Fireball Classic
52	off	off	on	off	on	on	off	off	cybrnaut	Cybernaut
53	on	off	on	off	on	on	off	off	myststar	Mystic Star
54	off	on	on	off	on	on	off	off	bullseye	301/Bullseye
55	on	on	on	off	on	on	off	off	notused1	notused1
56	off	off	off	on	on	on	off	off	notused2	notused2
57	on	off	off	on	on	on	off	off	notused3	notused3
58	off	on	off	on	on	on	off	off	notused4	notused4
59	on	on	off	on	on	on	off	off	notused5	notused5
60	off	off	on	on	on	on	off	off	notused6	notused6
61	on	off	on	on	on	on	off	off	blkshpsq	Black Sheep Squadron
62	off	on	on	on	on	on	off	off	st_game	Unknown Game (Unknown)
63	on	on	on	on	on	on	off	off	pinball	Pinball
64	off	off	off	off	off	off	on	off	stingray	Stingray
65	on	off	off	off	off	off	on	off	stars	Stars
66	off	on	off	off	off	off	on	off	memlane	Memory Lane
67	on	on	off	off	off	off	on	off	lectrono	Lectronamo
68	off	off	on	off	off	off	on	off	wildfyre	Wildfyre
69	on	off	on	off	off	off	on	off	nugent	Nugent
70	off	on	on	off	off	off	on	off	dracula	Dracula
71	on	on	on	off	off	off	on	off	trident	Trident
72	off	off	off	on	off	off	on	off	hothand	Hot Hand
73	on	off	off	on	off	off	on	off	magic	Magic
74	off	on	off	on	off	off	on	off	princess	Cosmic Princess
75	on	on	off	on	off	off	on	off	meteor	Meteor
76	off	off	on	on	off	off	on	off	galaxy	Galaxy
77	on	off	on	on	off	off	on	off	ali	Ali
78	off	on	on	on	off	off	on	off	biggame	Big Game
79	on	on	on	on	off	off	on	off	seawitch	Seawitch
80	off	off	off	off	on	off	on	off	cheetah	Cheetah

81	on	off	off	off	on	off	on	off	quicksil	Quicksilver
82	off	on	off	off	on	off	on	off	stargzr	Star Gazer
83	on	on	off	off	on	off	on	off	flight2k	Flight 2000
84	off	off	on	off	on	off	on	off	nineball	Nine Ball
85	on	off	on	off	on	off	on	off	freefall	Free Fall
86	off	on	on	off	on	off	on	off	lightnin	Lightning
87	on	on	on	off	on	off	on	off	splitsec	Split Second
88	off	off	off	on	on	off	on	off	catacomb	Catacomb
89	on	off	off	on	on	off	on	off	ironmaid	Iron Maiden
90	off	on	off	on	on	off	on	off	viper	Viper
91	on	on	off	on	on	off	on	off	dragfist	Dragonfist
92	off	off	on	on	on	off	on	off	orbitor1	Orbitor 1
93	on	off	on	on	on	off	on	off	cue	Cue
94	off	on	on	on	on	off	on	off	lazrlord	Lazer Lord
95	on	on	on	on	on	off	on	off	notused7	notused1
96	off	off	off	off	off	on	on	off	notused8	notused8
97	on	off	off	off	off	on	on	off	notused9	notused9
98	off	on	off	off	off	on	on	off	notused10	notused10
99	on	on	off	off	off	on	on	off	notused11	notused11
100	off	off	on	off	off	on	on	off	nightr20	Night Rider (rev. 20
101	on	off	on	off	off	on	on	off	nightrdb	Night Rider (Free Play)
102	off	on	on	off	off	on	on	off	evelknib	Evel Knievel (Free Play)
103	on	on	on	off	off	on	on	off	eightblb	Eight Ball (Free Play)
104	off	off	off	on	off	on	on	off	pwerplab	Power Play (Free Play)
105	on	off	off	on	off	on	on	off	matatest	Mata Hari (New game rules)
106	off	on	off	on	off	on	on	off	mataharb	Mata Hari (Free Play)
107	on	on	off	on	off	on	on	off	stk_sprb	Strikes and Spares (Free Play)
108	off	off	on	on	off	on	on	off	blackjcb	Black Jack (Free Play)
109	on	off	on	on	off	on	on	off	lostwldb	Lost World (Free Play)
110	off	on	on	on	off	on	on	off	smmanb	The Six Million Dollar Man (7-digit conversion rev. 20)
111	on	on	on	on	off	on	on	off	smmanc	The Six Million Dollar Man (7-digit rev. 3 Free Play)
112	off	off	off	off	on	on	on	off	smmand	The Six Million Dollar Man (/10 Free Play)
113	on	off	off	off	on	on	on	off	playboyb	Playboy (7-digit conversion rev. 20)
114	off	on	off	off	on	on	on	off	playboyc	Playboy (7-digit rev. 3 Free Play)
115	on	on	off	off	on	on	on	off	playboyd	Playboy (/10 Free Play)
116	off	off	on	off	on	on	on	off	voltanb	Voltan Escapes Cosmic Doom (7-digit conversion rev. 20)
117	on	off	on	off	on	on	on	off	voltanc	Voltan Escapes Cosmic Doom (7-digit rev. 3 Free Play)
118	off	on	on	off	on	on	on	off	voltand	Voltan Escapes Cosmic Doom (/10 Free Play)
119	on	on	on	off	on	on	on	off	sstb	Supersonic (7-digit conversion rev. 20)
120	off	off	off	on	on	on	on	off	sstc	Supersonic (7-digit rev. 3 Free Play)
121	on	off	off	on	on	on	on	off	sstd	Supersonic (/10 Free Play)
122	off	on	off	on	on	on	on	off	startreb	Star Trek (7-digit conversion rev. 20)

123	on	on	off	on	on	on	on	off	startrec	Star Trek (7-digit rev. 3 Free Play)
124	off	off	on	on	on	on	on	off	startred	Star Trek (/10 Free Play)
125	on	off	on	on	on	on	on	off	paragonb	Paragon (7-digit conversion rev. 20)
126	off	on	on	on	on	on	on	off	paragonc	Paragon (7-digit rev. 3 Free Play)
127	on	on	on	on	on	on	on	off	paragond	Paragon (/10 Free Play)
128	off	off	off	off	off	off	off	on	hglbtrtb	Harlem Globetrotters (7-digit conversion)
129	on	off	off	off	off	off	off	on	dollyptb	Dolly Parton (7-digit conversion)
130	off	on	off	off	off	off	off	on	kissb	Kiss (7-digit conversion rev. 20)
131	on	on	off	off	off	off	off	on	kissc	Kiss (7-digit rev. 3 Free Play)
132	off	off	on	off	off	off	off	on	kissd	Kiss (/10 Free Play)
133	on	off	on	off	off	off	off	on	futurspb	Future Spa (7-digit conversion)
134	off	on	on	off	off	off	off	on	spaceinb	Space Invaders (7-digit conversion)
135	on	on	on	off	off	off	off	on	ngndshkb	Nitro Groundshaker (7-digit conversion)
136	off	off	off	on	off	off	off	on	slbmanib	Silverball Mania (7-digit conversion)
137	on	off	off	on	off	off	off	on	rollstob	Rolling Stones (7-digit conversion)
138	off	on	off	on	off	off	off	on	mysticb	Mystic (7-digit conversion)
139	on	on	off	on	off	off	off	on	hotdogga	Hot Doggin (Free Play)
140	off	off	on	on	off	off	off	on	hotdoggb	Hot Doggin (7-digit conversion)
141	on	off	on	on	off	off	off	on	vikingb	Viking (7-digit conversion)
142	off	on	on	on	off	off	off	on	skateblb	Skateball (alternate set rev. 3)
143	on	on	on	on	off	off	off	on	skatebla	Skateball (Free Play)
144	off	off	off	off	on	off	off	on	frontiea	Frontier (Free Play)
145	on	off	off	off	on	off	off	on	xenonf	Xenon (French)
146	off	on	off	off	on	off	off	on	xenona	Xenon (Free Play)
147	on	on	off	off	on	off	off	on	xenonfa	Xenon (French Free Play)
148	off	off	on	off	on	off	off	on	flashgdv	Flash Gordon (Vocalizer Sound)
149	on	off	on	off	on	off	off	on	flashgva	Flash Gordon (Vocalizer Sound Free Play)
150	off	on	on	off	on	off	off	on	flashgda	Flash Gordon (Free Play)
151	on	on	on	off	on	off	off	on	flashgdf	Flash Gordon (French)
152	off	off	off	on	on	off	off	on	flashgfa	Flash Gordon (French Free Play)
153	on	off	off	on	on	off	off	on	eballd14	Eight Ball Deluxe (rev. 14)
154	off	on	off	on	on	off	off	on	eballdla	Eight Ball Deluxe (Free Play)
155	on	on	off	on	on	off	off	on	eballdlb	Eight Ball Deluxe (modified rules rev. 29)
156	off	off	on	on	on	off	off	on	eballdlc	Eight Ball Deluxe (modified rules rev. 32)
157	on	off	on	on	on	off	off	on	fball_ia	Fireball II (Free Play)
158	off	on	on	on	on	off	off	on	embryona	Embryon (Free Play)
159	on	on	on	on	on	off	off	on	embryonb	Embryon (7-digit conversion rev. 1)
160	off	off	off	off	off	on	off	on	embryonc	Embryon (7-digit conversion rev. 8)
161	on	off	off	off	off	on	off	on	embryond	Embryon (7-digit conversion rev. 9)
162	off	on	off	off	off	on	off	on	fathoma	Fathom (Free Play)
163	on	on	off	off	off	on	off	on	fathomb	Fathom (modified rules)
164	off	off	on	off	off	on	off	on	medusaa	Medusa (Free Play)

165	on	off	on	off	off	on	off	on	medusaf	Medusa (6802 board)
166	off	on	on	off	off	on	off	on	centaura	Centaur (Free Play)
167	on	on	on	off	off	on	off	on	centaurb	Centaur (Free Play rev. 27)
168	off	off	off	on	off	on	off	on	elektraa	Elektra (Free Play)
169	on	off	off	on	off	on	off	on	vectora	Vector (Free Play)
170	off	on	off	on	off	on	off	on	vectorb	Vector (modified rules)
171	on	on	off	on	off	on	off	on	spectrua	Spectrum (Free Play)
172	off	off	on	on	off	on	off	on	spectru4	Spectrum (rev. 4)
173	on	off	on	on	off	on	off	on	spectr4a	Spectrum (rev. 4 Free Play)
174	off	on	on	on	off	on	off	on	speakesa	Speakeasy (Free Play)
175	on	on	on	on	off	on	off	on	speakes4	Speakeasy (4 Players)
176	off	off	off	off	on	on	off	on	speake4a	Speakeasy (4 Players Free Play)
177	on	off	off	off	on	on	off	on	rapidfia	Rapid Fire (Free Play)
178	off	on	off	off	on	on	off	on	m_mpaca	Mr. & Mrs. Pac-Man Pinball (Free Play)
179	on	on	off	off	on	on	off	on	bmxa	BMX (Free Play)
180	off	off	on	off	on	on	off	on	granslaa	Grand Slam (Free Play)
181	on	off	on	off	on	on	off	on	gransla4	Grand Slam (4 Players)
182	off	on	on	off	on	on	off	on	gransl4a	Grand Slam (4 Players Free Play)
183	on	on	on	off	on	on	off	on	goldbalb	Gold Ball (7-digit conversion)
184	off	off	off	on	on	on	off	on	goldbalc	Gold Ball (6/7-digit alternate set rev. 12)
185	on	off	off	on	on	on	off	on	goldbaln	Gold Ball (alternate set)
186	off	on	off	on	on	on	off	on	xsandosa	X's & O's (Free Play)
187	on	on	off	on	on	on	off	on	kosteela	Kings of Steel (Free Play)
188	off	off	on	on	on	on	off	on	blakpyrb	Black Pyramid (Free Play)
189	on	off	on	on	on	on	off	on	spyhunta	Spy Hunter (Free Play)
190	off	on	on	on	on	on	off	on	fbclassa	Fireball Classic (Free Play)
191	on	on	on	on	on	on	off	on	cybrnaua	Cybernaut (Free Play)
192	off	off	off	off	off	off	on	on	notused12	notused12
193	on	off	off	off	off	off	on	on	notused13	notused13
194	off	on	off	off	off	off	on	on	notused14	notused14
195	on	on	off	off	off	off	on	on	notused15	notused15
196	off	off	on	off	off	off	on	on	notused16	notused16
197	on	off	on	off	off	off	on	on	notused17	notused17
198	off	on	on	off	off	off	on	on	notused18	notused18
199	on	on	on	off	off	off	on	on	notused19	notused19
200	off	off	off	on	off	off	on	on	gamatron	Gamatron
201	on	off	off	on	off	off	on	on	pinbalfp	Pinball (Free Play)
202	off	on	off	on	off	off	on	on	stingrfp	Stingray (Free Play)
203	on	on	off	on	off	off	on	on	starsfp	Stars (Free Play)
204	off	off	on	on	off	off	on	on	memlanfp	Memory Lane (Free Play)
205	on	off	on	on	off	off	on	on	lectrofp	Lectronamo (Free Play)
206	off	on	on	on	off	off	on	on	wildfyfp	Wildfyre (Free Play)

207	on	on	on	on	off	off	on	on	nugentfp	Nugent (Free Play)
208	off	off	off	off	on	off	on	on	draculfp	Dracula (Free Play)
209	on	off	off	off	on	off	on	on	tridenfp	Trident (Free Play)
210	off	on	off	off	on	off	on	on	hothanfp	Hot Hand (Free Play)
211	on	on	off	off	on	off	on	on	magicfp	Magic (Free Play)
212	off	off	on	off	on	off	on	on	princefp	Cosmic Princess (Free Play)
213	on	off	on	off	on	off	on	on	meteorbf	Meteor (Bonus Count Fix)
214	off	on	on	off	on	off	on	on	meteorfp	Meteor (Free Play)
215	on	on	on	off	on	off	on	on	meteorb	Meteor (7-digit conversion)
216	off	off	off	on	on	off	on	on	meteorc	Meteor (7-digit conversion Free Play)
217	on	off	off	on	on	off	on	on	meteord	Meteor (/10 Scoring)
218	off	on	off	on	on	off	on	on	galaxyfp	Galaxy (Free Play)
219	on	on	off	on	on	off	on	on	galaxyb	Galaxy (7-digit bootleg)
220	off	off	on	on	on	off	on	on	alifp	Ali (Free Play)
221	on	off	on	on	on	off	on	on	biggamfp	Big Game (Free Play)
222	off	on	on	on	on	off	on	on	seawitfp	Seawitch (Free Play)
223	on	on	on	on	on	off	on	on	cheetahb	Cheetah (Blue cabinet)
224	off	off	off	off	off	on	on	on	cheetafp	Cheetah (Free Play)
225	on	off	off	off	off	on	on	on	cheetah1	Cheetah (Bonus shot 1/game)
226	off	on	off	off	off	on	on	on	cheetah2	Cheetah (Bonus shot 1/ball)
227	on	on	off	off	off	on	on	on	quicksfp	Quicksilver (Free Play)
228	off	off	on	off	off	on	on	on	stargzfp	Star Gazer (Free Play)
229	on	off	on	off	off	on	on	on	stargzrb	Star Gazer (modified rules rev. 9)
230	off	on	on	off	off	on	on	on	flightfp	Flight 2000 (Free Play)
231	on	on	on	off	off	on	on	on	ninebafp	Nine Ball (Free Play)
232	off	off	off	on	off	on	on	on	ninebalb	Nine Ball (modified rules rev. 85)
233	on	off	off	on	off	on	on	on	freefafp	Free Fall (Free Play)
234	off	on	off	on	off	on	on	on	lightnfp	Lightning (Free Play)
235	on	on	off	on	off	on	on	on	splitsfp	Split Second (Free Play)
236	off	off	on	on	off	on	on	on	catacofp	Catacomb (Free Play)
237	on	off	on	on	off	on	on	on	ironmafp	Iron Maiden (Free Play)
238	off	on	on	on	off	on	on	on	viperfp	Viper (Free Play)
239	on	on	on	on	off	on	on	on	dragfifp	Dragonfist (Free Play)
240	off	off	off	off	on	on	on	on	dragfisb	Dragonfist (Drop Target Score Bootleg)
241	on	off	off	off	on	on	on	on	dragfib2	Dragonfist (Drop Target Score Bootleg 2)
242	off	on	off	off	on	on	on	on	orbitofp	Orbitor 1 (Free Play)
243	on	on	off	off	on	on	on	on	orbitora	Orbitor 1 (Bootleg)
244	off	off	on	off	on	on	on	on	orbitorb	Orbitor 1 (Bootleg Free Play)
245	on	off	on	off	on	on	on	on	ngndshkm	Nitro Groundshaker (7-digit with sirene patch)

Appendix E: example dip switch setting 'default_lisy1_dips.csv'

Switch	ON_or_OFF	comment (Pinname default: 0x0, 0x3F, 0x73)
1	OFF	
2	OFF	
3	OFF	
4	OFF	
5	OFF	
6	OFF	
7	OFF	
8	OFF	
9	ON	
10	ON	
11	ON	
12	ON	
13	ON	
14	ON	
15	OFF	
16	OFF	
17	ON	
18	ON	
19	OFF	
20	ON	
21	ON	
22	ON	
23	ON	
24	OFF	

Appendix F: example dip switch setting 'default_lisy80_dips.csv'

Switch	ON_or_OFF	comment
1	OFF	
2	ON	
3	OFF	
4	OFF	
5	OFF	
6	OFF	
7	OFF	
8	OFF	
9	ON	
10	ON	
11	OFF	
12	OFF	
13	OFF	
14	OFF	
15	OFF	
16	ON	
17	ON	
18	ON	
19	OFF	
20	ON	
21	ON	
22	OFF	
23	ON	
24	ON	
25	ON	
26	ON	
27	ON	
28	ON	
29	ON	
30	ON	
31	ON	
32	ON	

Appendix G: Fadecandy example mapping GI

LED	Mode	follower	Red	Green	Blue	Comment (GI full mapping example)
64	1	0	239	90	16	
65	1	1	239	90	16	
66	1	2	239	90	16	
67	1	3	239	90	16	
68	1	4	239	90	16	
69	1	5	239	90	16	
70	1	6	239	90	16	

Appendix H: Fadecandy example mapping lamps

Lamp	Exclusiv	LED	Red	Green	Blue	Comment (full mapping example)
2	1	80	255	255	255	Shoot again backbox
10	1	79	255	255	255	Game Over
11	1	82	255	255	255	high game to date

Appendix I: Error codes

In case of Error, the red 'Error' LED will went to ON and (if possible) LISY will display the Error code in one of the displays. In debug mode the Error code will also appear in the debug log.

#	short message	long message	possible solution
1		"Failed to initialize the wiringPi library"	
2		"Failed to open the I2C bus for displays"	check X1
3		"Unable to get bus access to talk to display slave"	
4	"I2C COIL PIC PROB"	"Failed to open the I2C bus for coils"	check X1
5	"I2C COIL PIC PROB"	"Unable to get bus access to talk to display slave"	
6	"I2C BUS PROB WRIT"	"Failed to write to the I2C bus display pic"	
7	"I2C BUS PROB WRIT"	"Failed to write to the I2C bus coil pic"	
8	"I2C BUS PROB READ"	"Failed to read from the I2C bus display pic"	check/replace display PIC
9	"I2C BUS PROB READ"	"Failed to read from the I2C bus coil pic"	check/replace coil PIC
10	"ROM MISSING "	"Failed to read ROM data for selected game"	put pinname rom into folder
11	"INVALID HARDWARE "	"Could not determine Hardware revision"	check eeprom